



**MINISTRY OF WATER, SANITATION & IRRIGATION
CENTRAL RIFT VALLEY WATER WORKS DEVELOPMENT AGENCY**

BIDDING DOCUMENT

FOR

**CONSTRUCTION OF BEKIBON WATER SUPPLY PROJECT IN
BARINGO COUNTY**

TENDER No.

CRVWDA/BAR/BEK/WSP/GOK/42/2023-2024

PROGRAMME: GOK FY 2023-2024

CATEGORY: SPECIAL GROUP

CLOSING DATE: 27TH MARCH 2024

TIME: 12:00PM

© FEBRUARY 2024

Presentation of Fraudulent Documents is criminal.

**PART 1 : INSTRUCTIONS TO TENDERERS, CONTRACT DATA SHEET,
CONDITIONS OF CONTRACT, SPECIFICATIONS AND TENDER FORMS**

Fairness, Transparency & Accountability

TABLE OF CONTENTS

Fairness, Transparency & Accountability

INVITATION TO TENDER	V
APPENDIX TO THE PREFACE.....	vii
GUIDELINES FOR PREPARATION OF TENDER DOCUMENTS.....	vii
2. PART 1 - TENDERING PROCEDURES	vii
3. PART 2 - PROCUREMENT ENTITY'S REQUIREMENTS	vii
4. PART 3 - CONDITIONS OF CONTRACT AND CONTRACT FORMS.....	viii
INVITATION TO TENDER.....	X
<u>SECTION I - INSTRUCTIONS TO TENDERERS</u>	<u>1</u>
A. General Provisions	1
1. Scope of Tender	1
2. Fraud and Corruption.....	1
3. Eligible Tenderers	1
4. Eligible Goods, Equipment, and Services.....	3
5. Tenderer's Responsibilities.....	3
B. Contents of Tender Documents	3
6. Sections of Tender Document	3
7. Site visit.....	4
8. Pre-Tender Meeting	4
9. Clarification and amendment of Tender Documents.....	5
10. Amendment of Tender Documents.....	5
C. Preparation of Tenders.....	5
11. Cost of Tendering.....	5
12. Language of Tender	5
13. Documents Comprising the Tender.....	5
14. Form of Tender and Schedules	6
15. Alternative Tenders.....	6
16. Tender Prices and Discounts.....	6
17. Currencies of Tender and Payment.....	7
18. Documents Comprising the Technical Proposal	7
19. Documents Establishing the Eligibility and Qualifications of the Tenderer	
20. Period of Validity of Tenders.....	8
21. Tender Security	8
22. Format and Signing of Tender.....	9
D Sealing and Marking of Tenders	9
23. Sealing and Marking of Tenders	9
24. Deadline for Submission of Tenders	10
25. Late Tenders.....	10
26. Withdrawal, Substitution, and Modification of Tenders	10
27. Tender Opening	10
E. Evaluation and Comparison of Tenders.....	11
28. Confidentiality.....	11
29. Clarification of Tenders.....	11
30. Deviations, Reservations, and Omissions	12
31. Determination of Responsiveness	12
32. Non-material Non-conformities	12
33. Arithmetical Errors.....	12
34. Conversion to Single Currency	13

35.	Margin of Preference and Reservations	13
36.	Subcontractors	13
37.	Evaluation of Tenders.....	13
38.	Comparison of Tenders	14
39.	Abnormally Low Tenders	14
40.	Abnormally High Tenders	14
41.	Unbalanced and/or Front-Loaded Tenders	14
42.	Qualifications of the Tenderer.....	15
43.	Best Evaluated Tender.....	15
44.	Procuring Entity's Right to Accept Any Tender, and to Reject Any or All Tenders	15
F.	Award of Contract.....	15
45.	Award Criteria.....	15
46.	Notice of Intention to enter into a Contract	15
47.	Standstill Period	16
48.	Debriefing by the Procuring Entity	16
49.	Letter of Award	16
50.	Signing of Contract	16
51.	Appointment of Adjudicator	16
52.	Performance Security.	16
53.	Publication of Procurement Contract.....	17
53.	Procurement Related Complaints.....	17
	SECTION II-TENDER DATA SHEET(TDS)	18
	SECTION III - EVALUATION AND QUALIFY ON CRITERIA.....	23
1.	General Provisions	23
2.	Preliminary examination for Determination of Responsiveness.....	23
3.	Tender Evaluation (ITT 35).....	23
4.	Multiple Contracts.....	23
5.	Alternative Tenders (ITT 13.1).....	24
6.	Margin of Preference is not applicable	24
7.	Post qualification and Contract award (ITT 39), more specifically	24
	SECTION IV – TENDERING FORMS	25
	QUALIFICATION FORMS.....	28
1.	Form Equ. Equipment	28
2.	Form per-1	29
4.	FORM PER-2:	30
5.	TENDERERS QUALIFICATION WITHOUT PRE-QUALIFICATION	32
	FORM ELI -1.1	32
	FORM ELI -1.2.....	33
	FORM CON – 2.....	34
5.4	FORM FIN – 3.1:	36
5.5	FORM FIN – 3.2:	37
5.6	FORM FIN – 3.3:	38
5.7	FORM FIN – 3.4:	38
5.8	FORM EXP - 4.1.....	39
5.9	FORM EXP - 4.2(a)	40

5.11	FORM EXP - 4.2(b)	41
	OTHER FORMS	42
6.	FORM OF TENDER	42
a)	TENDERER'S ELIGIBILITY- CONFIDENTIAL BUSINESS QUESTIONNAIRE	45
b)	CERTIFICATE OF INDEPENDENT TENDER DETERMINATION	48
c)	SELF-DECLARATION FORM - SELF DECLARATION OF THE TENDERER	49
d)	APPENDIX 1- FRAUD AND CORRUPTION	52
7.	FORM OF TENDER SECURITY - DEMAND BANK GUARANTEE	54
8.	FORM OF TENDER SECURITY (INSURANCE GUARANTEE)	55
9.	FORM OF TENDER-SECURING DECLARATION	56
10.	APPENDIX TO TENDER	57
	PART II - WORK REQUIREMENTS	58
	SECTION V - DRAWINGS	58
	SECTION VI - SPECIFICATIONS	58
	SECTION VII - BILLS OF QUANTITIES	59
1.	Objectives	59
2.	Day work Schedule	59
3.	Provisional Sums	59
4.	The Bills of Quantities	59
	PART III-CONDITIONS OF CONTRACT AND CONTRACT FORMS	60
	SECTION VIII - GENERAL CONDITIONS OF CONTRACT	60
	A. General	
1.	Definitions	61
2.	Interpretation	61
3.	Language and Law	62
4.	Project Manager's Decisions	63
5.	Delegation	63
6.	Communications	63
7.	Subcontracting	63
8.	Other Contractors	63
9.	Personnel and Equipment	63
10.	Procuring Entity's and Contractor's Risks	63
11.	Procuring Entity's Risks	63
12.	Contractor's Risks	64
13.	Insurance	64
14.	Site Data	64
15.	Contractor to Construct the Works	64
16.	The Works to Be Completed by the Intended Completion Date	64
17.	Approval by the Project Manager	64
18.	Safety	65
19.	Discoveries	65
20.	Possession of the Site	65
21.	Access to the Site	65
22.	Instructions, Inspections and Audits	65
23.	Appointment of the Adjudicator	65
24.	Settlement of Claims and Disputes	66
25.	Fraud and Corruption	68
	B. Time Control	68

1.	Program	68
2.	Extension of the Intended Completion Date	69
3.	Acceleration	69
4.	Delays Ordered by the Project Manager	69
5.	Management Meetings	69
6.	Early Warning	70
	Quality Control 69	
7.	Identifying Defects.....	69
8.	Tests	69
9.	Correction of Defects	69
10.	Uncorrected Defects	69
C.	Cost Control.....	70
1.	Contract Price.....	70
2.	Changes in the Contract Price.....	70
3.	Variations	71
4.	Cash Flow Forecasts.....	72
5.	Payment Certificates	72
6.	Payments	72
7.	Compensation Events	73
8.	Tax.....	73
9.	Currency y of Payment.....	73
10.	Price Adjustment	73
11.	Retention	74
12.	Liquidated Damages	74
13.	Bonus.....	74
14.	Advance Payment.....	74
15.	Securities	75
16.	Dayworks	75
17.	Cost of Repairs.....	75
D.	Finishing the Contract	75
1.	Completion.....	75
2.	Taking Over	75
3.	Final Account	75
4.	Operating and Maintenance Manuals	75
5.	Termination	76
6.	Payment upon Termination	76
7.	Property	76
8.	Release from Performance	76
	SECTION IX - SPECIAL CONDITIONS OF CONTRACT.....	77
	SECTION X - CONTRACT FORMS	88
	FORM No. 1 - NOTIFICATION OF INTENTION TO AWARD	80
	FORM No. 2 – REQUEST FOR REVIEW.....	83
	FORM No. 3 - LETTER OF AWARD	83
	FORM No. 4 - CONTRACT AGREEMENT.....	84
	FORM No. 5 - PERFORMANCE SECURITY [Option 1 - Unconditional Demand Bank Guarantee]	85
	FORM No. 6- PERFORMANCE SECURITY [Option 2– Performance Bond]	86
	FORM No. 7- ADVANCE PAYMENT SECURITY	88
	FORM No. 8- RETENTION MONEY SECURITY	87
	FORM No. 9- BENEFICIAL OWNERSHIP DISCLOSURE FORM.....	87

INVITATION TO TENDER

Central Rift Valley Water Works Development Agency of P. O Box 2451-20100, Nakuru

Contract Name and Description: Construction of Bekibon Water Supply Project in Baringo County

The **Central Rift Valley Water Works Development Agency** invites sealed tenders for the **Construction of Bekibon Water Supply Project in Baringo County**

1. Tendering will be conducted under open competitive method using a standardized tender document. Tendering is open to all qualified and interested Tenderers.
2. Qualified and interested tenderers may obtain further information and inspect the Tender Documents during office hours *0800 to 1700 hours* at the address given below. More details on the works are provided in **PART 2 - works' Requirements**, Section V - Description of Services of the Tender Document.
3. A complete set of tender documents may be obtained by interested tenderers electronically from the Website www.crvwwda.go.ke/ or www.tenders.go.ke . Tender documents obtained electronically will be free of charge.

Tender documents may be viewed and downloaded for free from the Agency or at the Public Procurement Information Portal www.crvwwda.go.ke/ or www.tenders.go.ke . Tenderers who download the tender document must forward their particulars immediately to procurement@crvwwda.go.ke to facilitate any further clarification or addendum.

4. The Tenderer shall chronologically serialize all pages of the tender documents submitted.
5. Completed tenders must be delivered to the address below on or before **1200Hrs on 27th March 2024**
6. Electronic Tenders *will not* be permitted.
7. Tenders will be opened immediately after the deadline date and time specified above or any deadline date and time specified later. Tenders will be publicly opened in the presence of the Tenderers' designated representatives who choose to attend at the address below.
9. Late tenders will be rejected.
10. The Pre-bid site visit is scheduled for **10:00am on 13th March 2024 at Bekibon Chief's Office, Baringo South Sub-County, Baringo County**
11. The addresses referred to above are:

A. Address for obtaining further information

CENTRAL RIFT VALLEY WATER WORKS DEVELOPMENT AGENCY
P.O Box 2451-20100, Nakuru,
TEL: 0725999000,
Email: info@crvwwda.go.ke/ procurement@crvwwda.go.ke
Website: www.crvwwda.go.ke

B. Address for Submission of Tenders

CENTRAL RIFT VALLEY WATER WORKS DEVELOPMENT AGENCY
Maji Plaza, Prisons Road
P.O Box 2451-20100, Nakuru,
TEL: 0725999000,
Email: info@crvwwda.go.ke
Website: www.crvwwda.go.ke

C. Address for Opening of Tenders.

CENTRAL RIFT VALLEY WATER WORKS DEVELOPMENT AGENCY
Maji Plaza, Prisons Road
P.O Box 2451-20100, Nakuru,

[Authorized Official (name, designation, Signature and date)]

Name: _____ (Official of the Procuring
Entity issuing the invitation)

Designation..... Signature.....Date

PART 1 - TENDERING PROCEDURES

Fairness, Transparency & Accountability

SECTION I: INSTRUCTIONS TO TENDERERS

A General Provisions

1. Scope of Tender

- 1.1 The Procuring Entity as defined in the Appendix to Conditions of Contract invites tenders for Works Contract as described in the tender documents. The name, identification, and number of lots (contracts) of this Tender Document are **specified in the TDS**.

2. Fraud and Corruption

2.1 The Procuring Entity requires compliance with the provisions of the Public Procurement and Asset Disposal Act, 2015, Section 62 “Declaration not to engage in corruption”. The tender submitted by a person shall include a declaration that the person shall not engage in any corrupt or fraudulent practice and a declaration that the person or his or her sub-contractors are not debarred from participating in public procurement proceedings.

2.2 The Procuring Entity requires compliance with the provisions of the Competition Act 2010, regarding collusive practices in contracting. Any tenderer found to have engaged in collusive conduct shall be disqualified and criminal and/or civil sanctions may be imposed. To this effect, Tenders shall be required to complete and sign the “Certificate of Independent Tender Determination” annexed to the Form of Tender.

2.3 Unfair Competitive Advantage - Fairness and transparency in the tender process require that the firms or their Affiliates competing for a specific assignment do not derive a competitive advantage from having provided consulting services related to this tender. To that end, the Procuring Entity shall indicate in the **Data Sheet** and make available to all the firms together with this tender document all information that would in that respect give such firm any unfair competitive advantage over competing firms.

2.4 Unfair Competitive Advantage - Fairness and transparency in the tender process require that the Firms or their Affiliates competing for a specific assignment do not derive a competitive advantage from having provided consulting services related to this tender being tendered for. The Procuring Entity shall indicate in the **TDS** firms (if any) that provided consulting services for the contract being tendered for. The Procuring Entity shall check whether the owners or controllers of the Tenderer are same as those that provided consulting services. The Procuring Entity shall, upon request, make available to any tenderer information that would give such firm unfair competitive advantage over competing firms.

3. Eligible Tenderers

3.1 A Tenderer may be a firm that is a private entity, a state-owned enterprise or institution subject to ITT 3.7 or any combination of such entities in the form of a joint venture (JV) under an existing agreement or with the intent to enter into such an agreement supported by a letter of intent. Public employees and their close relatives (*spouses, children, brothers, sisters and uncles and aunts*) are not eligible to participate in the tender. In the case of a joint venture, all members shall be jointly and severally liable for the execution of the entire Contract in accordance with the Contract terms. The JV shall nominate a Representative who shall have the authority to conduct all business for and on behalf of any and all the members of the JV during the tendering process and, in the event the JV is awarded the Contract, during contract execution. The maximum number of JV members shall be specified in the **TDS**.

3.2 Public Officers of the Procuring Entity, their Spouses, Child, Parent, Brothers or Sister. Child, Parent, Brother or Sister of a Spouse, their business associates or agents and

firms/organizations in which they have a substantial or controlling interest shall not be eligible to tender or be awarded a contract. Public Officers are also not allowed to participate in any procurement proceedings.

3.3 A Tenderer shall not have a conflict of interest. Any tenderer found to have a conflict of interest shall be disqualified. A tenderer may be considered to have a conflict of interest for the purpose of this tendering process, if the tenderer:

- a) Directly or indirectly controls, is controlled by or is under common control with another tenderer; or
- b) Receives or has received any direct or indirect subsidy from another tenderer; or
- c) Has the same legal representative as another tenderer; or
- d) Has a relationship with another tenderer, directly or through common third parties, that puts it in a position to influence the tender of another tenderer, or influence the decisions of the Procuring Entity regarding this tendering process; or
- e) Any of its affiliates participated as a consultant in the preparation of the design or technical specifications of the works that are the subject of the tender; or
- f) any of its affiliates has been hired (or is proposed to be hired) by the Procuring Entity as Engineer for the Contract implementation; or
- g) Would be providing goods, works, or non-consulting services resulting from or directly related to consulting services for the preparation or implementation of the contract specified in this Tender Document or
- h) Has a close business or family relationship with a professional staff of the Procuring Entity who?
 - i) are directly or indirectly involved in the preparation of the Tender document or specifications of the Contract, and/or the Tender evaluation process of such contract; or
 - ii) would be involved in the implementation or supervision of such Contract unless the conflict stemming from such relationship has been resolved in a manner acceptable to the Procuring Entity throughout the tendering process and execution of the Contract.

3.4 A tenderer shall not be involved in corrupt, coercive, obstructive, collusive or fraudulent practice. A tenderer that is proven to have been involved any of these practices shall be automatically disqualified.

3.5 A Tenderer (either individually or as a JV member) shall not participate in more than one Tender, except for permitted alternative tenders. This includes participation as a subcontractor in other Tenders. Such participation shall result in the disqualification of all Tenders in which the firm is involved. A firm that is not a tenderer or a JV member may participate as a subcontractor in more than one tender. Members of a joint venture may not also make an individual tender, be a subcontractor in a separate tender or be part of another joint venture for the purposes of the same Tender.

3.6 A Tenderer may have the nationality of any country, subject to the restrictions pursuant to ITT 4.8.A. Tenderer shall be deemed to have the nationality of a country if the Tenderer is constituted, incorporated or registered in and operates in conformity with the provisions of the laws of that country, as evidenced by its articles of incorporation (or equivalent documents of constitution or association) and its registration documents, as the case may be. This criterion also shall apply to the determination of the nationality of proposed subcontractors or sub-consultants for any part of the Contract including related Services.

3.7 Tenderer that has been debarred from participating in public procurement shall be ineligible to tender or be awarded a contract. The list of debarred firms and individuals is available from the website of PPRA www.ppra.go.ke.

3.8 Tenderers that are state-owned enterprises or institutions may be eligible to compete and be awarded a Contract(s) only if they are accredited by PPRA to be (i) a legal public entity of the state Government and/or public administration, (ii) financially autonomous and not receiving any significant subsidies or budget support from any public entity or Government, and (iii) operating under commercial law and vested with legal rights and liabilities similar to any commercial enterprise to enable it compete with firms in the private sector on an equal basis.

3.9 A Firms and individuals may be ineligible if their countries of origin (a) as a matter of law or official regulations, Kenya prohibits commercial relations with that country, or (b) by an act of compliance with a decision of the United Nations Security Council taken under Chapter VII of the Charter of the United Nations, Kenya prohibits any import of goods or contracting of works or services from that country, or any payments to any country, person, or entity in that country. A tenderer shall provide such documentary evidence of eligibility satisfactory to the Procuring Entity, as the Procuring Entity shall reasonably request.

3.10 Foreign tenderers are required to source at least forty (40%) percent of their contract inputs (in supplies, subcontracts and labor) from national suppliers and contractors. To this end, a foreign tenderer shall provide in its tender documentary evidence that this requirement is met. Foreign tenderers not meeting this criterion will be automatically disqualified. Information required to enable the Procuring Entity determine if this condition is met shall be provided in for this purpose is be provided in “*SECTION III - EVALUATION AND QUALIFICATION CRITERIA, Item9*”.

3.11 Pursuant to the eligibility requirements of ITT 4.10, a tender is considered a foreign tenderer, if the tenderer is not registered in Kenya or if the tenderer is registered in Kenya and has less than 51 percent ownership by Kenyan

Citizens. JVs are considered as foreign tenderers if the individual member firms are not registered in Kenya or if are registered in Kenya and have less than 51 percent ownership by Kenyan citizens. The JV shall not subcontract to foreign firms more than 10 percent of the contract price, excluding provisional sums.

3.12 The National Construction Authority Act of Kenya requires that all local and foreign contractors be registered with the National Construction Authority and be issued with a Registration Certificate before they can undertake any construction works in Kenya. Registration shall not be a condition for tender, but it shall be a condition of contract award and signature. A selected tenderer shall be given opportunity to register before such award and signature of contract. Application for registration with National Construction Authority may be accessed from the website www.nca.go.ke.

3.13 The Competition Act of Kenya requires that firms wishing to tender as Joint Venture undertakings which may prevent, distort or lessen competition in provision of services are prohibited unless they are exempt in accordance with the provisions of Section 25 of the Competition Act, 2010. JVs will be required to seek for exemption from the Competition Authority. Exemption shall not be a condition for tender, but it shall be a condition of contract award and signature. A JV tenderer shall be given opportunity to seek such exemption as a condition of award and signature of contract. Application for exemption from the Competition Authority of Kenya may be accessed from the website www.cak.go.ke

3.14 A Kenyan tenderer shall provide evidence of having fulfilled his/her tax obligations by producing a valid tax clearance certificate or tax exemption certificate issued by the Kenya Revenue Authority.

4 Eligible Goods, Equipment, and Services

4.1 Goods, equipment and services to be supplied under the Contract may have their origin in any country that is not eligible under ITT 3.9. At the Procuring Entity's request, Tenderers may be required to provide evidence of the origin of Goods, equipment and services.

4.2 Any goods, works and production processes with characteristics that have been declared by the relevant national environmental protection agency or by other competent authority as harmful to human beings and to the environment shall not be eligible for procurement.

5. Tenderer's Responsibilities

5.1 The tenderer shall bear all costs associated with the preparation and submission of his/her tender, and the Procuring Entity will in no case be responsible or liable for those costs.

5.2 The tenderer, at the tenderer's own responsibility and risk, is encouraged to visit and examine the Site of the Works and its surroundings, and obtain all information that may be necessary for preparing the tender and entering into a contract for construction of the Works. The costs of visiting the Site shall be at the tenderer's own expense.

5.3 The Tenderer and any of its personnel or agents will be granted permission by the Procuring Entity to enter upon its premises and lands for the purpose of such visit. The Tenderer shall indemnify the Procuring Entity against all liability arising from death or personal injury, loss of or damage to property, and any other losses and expenses incurred as a result of the inspection.

5.4 The tenderer shall provide in the Form of Tender and Qualification Information, a preliminary description of the proposed work method and schedule, including charts, as necessary or required.

B. Contents of Tender Documents

6. Sections of Tender Document

6.1 The tender document consists of Parts 1, 2, and 3, which includes all the sections specified below, and which should be read in conjunction with any Addenda issued in accordance with ITT 8.

PART 1 Tendering Procedures

- i) Section I - Instructions to Tenderers (ITT)
- ii) Section II - Tender Data Sheet (TDS)
- iii) Section III - Evaluation and Qualification Criteria
- iv) Section IV - Tendering Forms

PART 2 Works Requirements

- i) Section V - Drawings
- ii) Section VI - Specifications
- iii) Section VII - Bills of Quantities

PART 3 Conditions of Contract and Contract Forms

- i) Section VIII - General Conditions of Contract (GCC)
- ii) Section IX - Special Conditions of Contract (SC)
- iii) Section X - Contract Forms

6.2 The Invitation to Tender Document (ITT) issued by the Procuring Entity is not part of the Contract documents.

6.3 Unless obtained directly from the Procuring Entity, the Procuring Entity is not responsible for the completeness of the Tender document, responses to requests for clarification, the minutes of the pre-Tender meeting (if any), or Addenda to the Tender document in accordance with ITT 8. In case of any contradiction, documents obtained directly from the Procuring Entity shall prevail.

The Tenderer is expected to examine all instructions, forms, terms, and specifications in the Tender Document and to furnish with its Tender all information and documentation as is required by the Tender document.

7. Site Visit

- 7.1 The Tenderer, at the Tenderer's own responsibility and risk, is encouraged to visit and examine and inspect the Site of the Required Services and its surroundings and obtain all information that may be necessary for preparing the Tender and entering into a contract for the Services. The costs of visiting the Site shall be at the Tenderer's own expense.

8. Pre-Tender Meeting

- 8.1 The Procuring Entity shall specify in the **TDS** if a pre-tender meeting will be held, when and where. The Procuring Entity shall also specify in the **TDS** if a pre-arranged pretender site visit will be held and when. The Tenderer's designated representative is invited to attend a pre-arranged pretender visit of the site of the works. The purpose of the meeting will be to clarify issues and to answer questions on any matter that may be raised at that stage.
- 8.2 The Tenderer is requested to submit any questions in writing, to reach the Procuring Entity not later than the period specified in the **TDS** before the meeting.
- 8.3 Minutes of the pre-Tender meeting and the pre-arranged pretender site visit of the site of the works, if applicable, including the text of the questions asked by Tenderers and the responses given, together with any responses prepared after the meeting, will be transmitted promptly to all Tenderers who have acquired the Tender Documents in accordance with ITT 6.3. Minutes shall not identify the source of the questions asked.
- 8.4 The Procuring Entity shall also promptly publish anonymized (*no names*) Minutes of the pre-Tender meeting and the pre-arranged pretender visit of the site of the works at the web page identified in the **TDS**. Any modification to the Tender Documents that may become necessary as a result of the pre-tender meeting and the pre-arranged pretender site visit, shall be made by the Procuring Entity exclusively through the issue of an Addendum pursuant to ITT 8 and not through the minutes of the pre-Tender meeting. Nonattendance at the pre-Tender meeting will not be a cause for disqualification of a Tenderer.

9. Clarification and amendments of Tender Documents

- 9.1 A Tenderer requiring any clarification of the Tender Document shall contact the Procuring Entity in writing at the Procuring Entity's address specified in the **TDS** or raise its enquiries during the pre-Tender meeting and the pre-arranged pretender visit of the site of the works if provided for in accordance with ITT 8.4. The Procuring Entity will respond in writing to any request for clarification, provided that such request is received no later than the period specified in the **TDS** prior to the deadline for submission of tenders. The Procuring Entity shall forward copies of its response to all tenderers who have acquired the Tender Documents in accordance with ITT 6.3, including a description of the inquiry but without identifying its source. If specified in the **TDS**, the Procuring Entity shall also promptly publish its response at the web page identified in the **TDS**. Should the clarification result in changes to the essential elements of the Tender Documents, the Procuring Entity shall amend the Tender Documents appropriately following the procedure under ITT 8.4.

10. Amendment of Tendering Document

- 10.1 At any time prior to the deadline for submission of Tenders, the Procuring Entity may amend

the Tendering document by issuing addenda.

10.2 Any addendum issued shall be part of the tendering document and shall be communicated in writing to all who have obtained the tendering document from the Procuring Entity in accordance with ITT 6.3. The Procuring Entity shall also promptly publish the addendum on the Procuring Entity's web page in accordance with ITT 8.4.

10.3 To give prospective Tenderers reasonable time in which to take an addendum into account in preparing their Tenders, the Procuring Entity shall extend, as necessary, the deadline for submission of Tenders, in accordance with ITT 25.2 below.

C Preparation of Tenders

11. Cost of Tendering

11.1 The Tenderer shall bear all costs associated with the preparation and submission of its Tender, and the Procuring Entity shall not be responsible or liable for those costs, regardless of the conduct or outcome of the tendering process.

12. Language of Tender

12.1 The Tender, as well as all correspondence and documents relating to the tender exchanged by the tenderer and the Procuring Entity, shall be written in the English Language. Supporting documents and printed literature that are part of the Tender may be in another language provided they are accompanied by an accurate and notarized translation of the relevant passages into the English Language, in which case, for purposes of interpretation of the Tender, such translation shall govern.

13. Documents Comprising the Tender

13.1 The Tender shall comprise the following:

- a) Form of Tender prepared in accordance with ITT 14;
- b) Schedules including priced Bill of Quantities, completed in accordance with ITT 14 and ITT 16;
- c) Tender Security or Tender-Securing Declaration, in accordance with ITT 21.1;
- d) Alternative Tender, if permissible, in accordance with ITT 15;
- e) Authorization: written confirmation authorizing the signatory of the Tender to commit the Tenderer, in accordance with ITT 22.3;
- f) Qualifications: documentary evidence in accordance with ITT 19 establishing the Tenderer's qualifications to perform the Contract if its Tender is accepted;
- g) Conformity: a technical proposal in accordance with ITT 18;
- h) Any other document required in the **TDS**.

13.2 In addition to the requirements under ITT 11.1, Tenders submitted by a JV shall include a copy of the Joint Venture Agreement entered into by all members. Alternatively, a letter of intent to execute a Joint Venture Agreement in the event of a successful Tender shall be signed by all members and submitted with the Tender, **together with a copy of the proposed Agreement. The Tenderer shall chronologically serialize pages of all tender documents submitted.**

13.3 The Tenderer shall furnish in the Form of Tender information on commissions and gratuities, if any, paid or to be paid to agents or any other party relating to this Tender.

14. Form of Tender and Schedules

14.1 The Form of Tender and Schedules, including the Bill of Quantities, shall be prepared using the relevant forms furnished in Section IV, Tendering Forms. The forms must be completed without any alterations to the text, and no substitutes shall be accepted except as provided under ITT 20.3. All blank spaces shall be filled in with the information requested.

15. Alternative Tenders

15.1 Unless otherwise specified in the **TDS**, alternative Tenders shall not be considered. 15.2 When alternative times for completion are explicitly invited, a statement to that effect will be included in the **TDS**, and the method of evaluating different alternative times for completion will be described in Section III, Evaluation and Qualification Criteria.

15.3 Except as provided under ITT 13.4 below, Tenderers wishing to offer technical alternatives to the requirements of the Tender Documents must first price the Procuring Entity's design as described in the Tender Documents and shall further provide all information necessary for a complete evaluation of the alternative by the Procuring Entity, including drawings, design calculations, technical specifications, breakdown of prices, and proposed construction methodology and other relevant details. Only the technical alternatives, if any, of the Tenderer with the Winning Tender conforming to the basic technical requirements shall be considered by the Procuring Entity. When specified in the **TDS**, Tenderers are permitted to submit alternative technical solutions for specified parts of the Works, and such parts will be identified in the **TDS**, as will the method for their evaluating, and described in Section VII, Works' Requirements.

16. Tender Prices and Discounts

16.1 The prices and discounts (including any price reduction) quoted by the Tenderer in the Form of Tender and in the Bill of Quantities shall conform to the requirements specified below.

16.2 The Tenderer shall fill in rates and prices for all items of the Works described in the Bill of Quantities. Items against which no rate or price is entered by the Tenderer shall be deemed covered by the rates for other items in the Bill of Quantities and will not be paid for separately by the Procuring Entity. An item not listed in the priced Bill of Quantities shall be assumed to be not included in the Tender, and provided that the Tender is determined substantially responsive notwithstanding this omission, the average price of the item quoted by substantially responsive Tenderers will be added to the Tender price and the equivalent total cost of the Tender so determined will be used for price comparison.

16.3 The price to be quoted in the Form of Tender, in accordance with ITT 14.1, shall be the total price of the Tender, including **VAT** and any discounts offered.

16.4 The Tenderer shall quote any discounts and the methodology for their application in the Form of Tender, in accordance with ITT 14.1.

16.5 It will be specified in the **TDS** if the rates and prices quoted by the Tenderer are or are not subject to adjustment during the performance of the Contract in accordance with the provisions of the Conditions of Contract, except in cases where the contract is subject to fluctuations and adjustments, not fixed price. In such a case, the Tenderer shall furnish the indices and weightings for the price adjustment formulae in the Schedule of Adjustment Data and the Procuring Entity may require the Tenderer to justify its proposed indices and

weightings.

16.6 Where tenders are being invited for individual lots (contracts) or for any combination of lots (packages), tenderers wishing to offer discounts for the award of more than one Contract shall specify in their Tender the price reductions applicable to each package, or alternatively, to individual Contracts within the package. Discounts shall be submitted in accordance with ITT 16.4, provided the Tenders for all lots (contracts) are opened at the same time.

16.7 All duties, taxes, and other levies payable by the Contractor under the Contract, or for any other cause, as of the date 30 days prior to the deadline for submission of Tenders, shall be included in the rates and prices and the total Tender Price submitted by the Tenderer.

17. Currencies of Tender and Payment

17.1 Tenderers shall quote entirely in Kenya Shillings. The unit rates and the prices shall be quoted by the Tenderer in the Bill of Quantities, entirely in Kenya shillings. A Tenderer expecting to incur expenditures in other currencies for inputs to the Works supplied from outside Kenya shall devise own ways of getting foreign currency to meet those expenditures.

18. Documents Comprising the Technical Proposal

18.1 The Tenderer shall furnish a technical proposal including a statement of work methods, equipment, personnel, schedule and any other information as stipulated in Section IV, Tender Forms, in sufficient detail to demonstrate the adequacy of the Tenderer's proposal to meet the work's requirements and the completion time.

19. Documents Establishing the Eligibility and Qualifications of the Tenderer

19.1 Tenderers shall complete the Form of Tender, included in Section IV, Tender Forms, to establish Tenderer's eligibility in accordance with ITT 4.

19.2 In accordance with Section III, Evaluation and Qualification Criteria, to establish its qualifications to perform the Contract the Tenderer shall provide the information requested in the corresponding information sheets included in Section IV, Tender Forms.

19.3 A margin of preference will not be allowed. Preference and reservations will be allowed, individually or in joint ventures. Applying for eligibility for Preference and reservations shall supply all information required to satisfy the criteria for eligibility specified in accordance with ITT 33.1.

19.4 Tenderers shall be asked to provide, as part of the data for qualification, such information, including details of ownership, as shall be required to determine whether, according to the classification established by the Procuring Entity, a contractor or group of contractors qualifies for a margin of preference. Further the information will enable the Procuring Entity identify any actual or potential conflict of interest in relation to the procurement and/or contract management processes, or a possibility of collusion between tenderers, and thereby help to prevent any corrupt influence in relation to the procurement process or contract management.

19.5 The purpose of the information described in ITT 19.4 above overrides any claims to confidentiality which a tenderer may have. There can be no circumstances in which it would be justified for a tenderer to keep information relating to its ownership and control confidential where it is tendering to undertake public sector work and receive public sector funds. Thus, confidentiality will not be accepted by the Procuring Entity as a justification

for a Tenderer's failure to disclose, or failure to provide required information on its ownership and control.

19.6 The Tenderer shall provide further documentary proof, information or authorizations that the Procuring Entity may request in relation to ownership and control which information on any changes to the information which was provided by the tenderer under ITT 6.3. The obligations to require this information shall continue for the duration of the procurement process and contract performance and after completion of the contract, if any change to the information previously provided may reveal a conflict of interest in relation to the award or management of the contract.

19.7 All information provided by the tenderer pursuant to these requirements must be complete, current and accurate as at the date of provision to the Procuring Entity. In submitting the information required pursuant to these requirements, the Tenderer shall warrant that the information submitted is complete, current and accurate as at the date of submission to the Procuring Entity.

19.8 If a tenderer fails to submit the information required by these requirements, its tender will be rejected. Similarly, if the Procuring Entity is unable, after taking reasonable steps, to verify to a reasonable degree the information submitted by a tenderer pursuant to these requirements, then the tender will be rejected.

19.9 If information submitted by a tenderer pursuant to these requirements, or obtained by the Procuring Entity (whether through its own enquiries, through notification by the public or otherwise), shows any conflict of interest which could materially and improperly benefit the tenderer in relation to the procurement or contract management process, then:

- i) if the procurement process is still ongoing, the tenderer will be disqualified from the procurement process,
- ii) if the contract has been awarded to that tenderer, the contract award will be set aside,
- iii) the tenderer will be referred to the relevant law enforcement authorities for investigation of whether the tenderer or any other persons have committed any criminal offence.

19.10 If a tenderer submits information pursuant to these requirements that is incomplete, inaccurate or out-of-date, or attempts to obstruct the verification process, then the consequences ITT 6.7 will ensue unless the tenderer can show to the reasonable satisfaction of the Procuring Entity that any such act was not material, or was due to genuine error which was not attributable to the intentional act, negligence or recklessness of the tenderer.

20. Period of Validity of Tenders

20.1 Tenders shall remain valid for the Tender Validity period specified in the **TDS**. The Tender Validity period starts from the date fixed for the Tender submission deadline (as prescribed by the Procuring Entity in accordance with ITT 24). A Tender valid for a shorter period shall be rejected by the Procuring Entity as non-responsive.

20.2 In exceptional circumstances, prior to the expiration of the Tender validity period, the Procuring Entity may request Tenderers to extend the period of validity of their Tenders. The request and the responses shall be made in writing. If a Tender Security is requested in accordance with ITT 21.1, it shall also be extended for thirty (30) days beyond the deadline of the extended validity period. A Tenderer may refuse the request without forfeiting its

Tender security. A Tenderer granting the request shall not be required or permitted to modify its Tender, except as provided in ITT 20.3.

20.3 If the award is delayed by a period exceeding the number of days to be specified in the **TDS** days beyond the expiry of the initial tender validity period, the Contract price shall be determined as follows:

- a) in the case of **fixed price** contracts, the Contract price shall be the tender price adjusted by the factor specified in the **TDS**;
- b) in the case of **adjustable price** contracts, no adjustment shall be made; or in any case, tender evaluation shall be based on the tender price without taking into consideration the applicable correction from those indicated above.

21. Tender Security

21.1 The Tenderer shall furnish as part of its Tender, either a Tender-Securing Declaration or a Tender Security as specified in the **TDS**, in original form and, in the case of a Tender Security, in the amount and currency specified in the **TDS**. A Tender-Securing Declaration shall use the form included in Section IV, Tender Forms.

21.2 If a Tender Security is specified pursuant to ITT 19.1, the Tender Security shall be a demand guarantee in any of the following forms at the Tenderer's option:

- a) an unconditional Bank Guarantee issued by reputable commercial bank); or
- b) an irrevocable letter of credit;
- c) a Banker's cheque issued by a reputable commercial bank; or
- d) another security specified **in the TDS**,

21.3 If an unconditional bank guarantee is issued by a bank located outside Kenya, the issuing bank shall have a correspondent bank located in Kenya to make it enforceable. The Tender Security shall be valid for thirty (30) days beyond the original validity period of the Tender, or beyond any period of extension if requested under ITT 20.2.

21.4 If a Tender Security or Tender-Securing Declaration is specified pursuant to ITT 19.1, any Tender not accompanied by a substantially responsive Tender Security or Tender-Securing Declaration shall be rejected by the Procuring Entity as non-responsive.

21.5 If a Tender Security is specified pursuant to ITT 21.1, the Tender Security of unsuccessful Tenderers shall be returned as promptly as possible upon the successful Tenderer's signing the Contract and furnishing the Performance Security and any other documents required in the **TDS**. The Procuring Entity shall also promptly return the tender security to the tenderers where the procurement proceedings are terminated, all tenders were determined nonresponsive or a bidder declines to extend tender validity period.

21.6 The Tender Security of the successful Tenderer shall be returned as promptly as possible once the successful Tenderer has signed the Contract and furnished the required Performance Security, and any other documents required in the **TDS**.

21.7 The Tender Security may be forfeited or the Tender-Securing Declaration executed:

- e) if a Tenderer withdraws its Tender during the period of Tender validity specified by the Tenderer on the Form of Tender, or any extension thereto provided by the Tenderer; or
- f) if the successful Tenderer fails to:
 - i) sign the Contract in accordance with ITT 50; or

- ii) furnish a Performance Security and if required in the **TDS**, and any other documents required in the **TDS**.

21.8 Where tender securing declaration is executed, the Procuring Entity shall recommend to the PPRA that PPRA debar the Tenderer from participating in public procurement as provided in the law.

21.9 The Tender Security or the Tender-Securing Declaration of a JV shall be in the name of the JV that submits the Tender. If the JV has not been legally constituted into a legally enforceable JV at the time of tendering, the Tender Security or the Tender-Securing Declaration shall be in the names of all future members as named in the letter of intent referred to in ITT 4.1 and ITT 11.2.

21.10 A tenderer shall not issue a tender security to guarantee itself.

22. Format and Signing of Tender

22.1 The Tenderer shall prepare one original of the documents comprising the Tender as described in ITT 13 and clearly mark it "ORIGINAL." Alternative Tenders, if permitted in accordance with ITT 15, shall be clearly marked "ALTERNATIVE." In addition, the Tenderer shall submit copies of the Tender, in the number specified in the **TDS** and clearly mark them "COPY." In the event of any discrepancy between the original and the copies, the original shall prevail.

22.2 Tenderers shall mark as "CONFIDENTIAL" all information in their Tenders which is confidential to their business. This may include proprietary information, trade secrets, or commercial or financially sensitive information.

22.3 The original and all copies of the Tender shall be typed or written in indelible ink and shall be signed by a person duly authorized to sign on behalf of the Tenderer. This authorization shall consist of a written confirmation as specified in the **TDS** and shall be attached to the Tender. The name and position held by each person signing the authorization must be typed or printed below the signature. All pages of the Tender where entries or amendments have been made shall be signed or initialed by the person signing the Tender.

22.4 In case the Tenderer is a JV, the Tender shall be signed by an authorized representative of the JV on behalf of the JV, and to be legally binding on all the members as evidenced by a power of attorney signed by their legally authorized representatives.

22.5 Any inter-lineation, erasures, or overwriting shall be valid only if they are signed or initialed by the person signing the Tender.

D. Submission and Opening of Tenders

23. Sealing and Marking of Tenders

- a) Depending on the sizes or quantities or weight of the tender documents, a tenderer may use an envelope, package or container. The Tenderer shall deliver the Tender in a single sealed envelope, or in a single sealed package, or in a single sealed container bearing the name and Reference number of the Tender, addressed to the Procuring Entity and a warning not to open before the time and date for Tender opening date. Within the single envelope, package or container, the Tenderer shall place the following separate, sealed envelopes: in an envelope or package or container marked

- “ORIGINAL”, all documents comprising the Tender, as described in ITT 11; and
- b) in an envelope or package or container marked “COPIES”, all required copies of the Tender; and
 - c) if alternative Tenders are permitted in accordance with ITT 15, and if relevant:
 - i) in an envelope or package or container marked “ORIGINAL – ALTERNATIVE TENDER”, the alternative Tender; and
 - ii) in the envelope or package or container marked “COPIES- ALTERNATIVE TENDER”, all required copies of the alternative Tender.

The inner envelopes or packages or containers shall:

- a) bear the name and address of the Procuring Entity.
- b) bear the name and address of the Tenderer; and
- c) bear the name and Reference number of the Tender.

23.2 If an envelope or package or container is not sealed and marked as required, the *Procuring Entity* will assume no responsibility for the misplacement or premature opening of the Tender. Tenders that are misplaced or opened prematurely will not be accepted.

24. Deadline for Submission of Tenders

24.1 Tenders must be received by the Procuring Entity at the address specified in the **TDS** and no later than the date and time also specified in the **TDS**. When so specified in the **TDS**, Tenderers shall have the option of submitting their Tenders electronically. Tenderers submitting Tenders electronically shall follow the electronic Tender submission procedures specified in the **TDS**.

24.2 The Procuring Entity may, at its discretion, extend the deadline for the submission of Tenders by amending the Tender Documents in accordance with ITT 8, in which case all rights and obligations of the Procuring Entity and Tenderers previously subject to the deadline shall thereafter be subject to the deadline as extended.

25. Late Tenders

25.1 The Procuring Entity shall not consider any Tender that arrives after the deadline for submission of tenders, in accordance with ITT 24. Any Tender received by the Procuring Entity after the deadline for submission of Tenders shall be declared late, rejected, and returned unopened to the Tenderer.

26. Withdrawal, Substitution, and Modification of Tenders

26.1 A Tenderer may withdraw, substitute, or modify its Tender after it has been submitted by sending a written notice, duly signed by an authorized representative, and shall include a copy of the authorization in accordance with ITT 22.3, (except that withdrawal notices do not require copies). The corresponding substitution or modification of the Tender must accompany the respective written notice. All notices must be:

- a) prepared and submitted in accordance with ITT 22 and ITT 23 (except that withdrawals notices do not require copies), and in addition, the respective envelopes shall be clearly marked “WITHDRAWAL,” “SUBSTITUTION,” “MODIFICATION; “and received by the Procuring Entity prior to the deadline prescribed for submission of Tenders, in accordance with ITT 24.

26.2 Tenders requested to be withdrawn in accordance with ITT 26.1 shall be returned unopened

to the Tenderers.

26.3 No Tender may be withdrawn, substituted, or modified in the interval between the deadline for submission of Tenders and the expiration of the period of Tender validity specified by the Tenderer on the Form of Tender or any extension thereof.

27. Tender Opening

27.1 Except in the cases specified in ITT 23 and ITT 26.2, the Procuring Entity shall publicly open and read out all Tenders received by the deadline, at the date, time and place specified in the **TDS**, in the presence of Tenderers' designated representatives who chooses to attend. Any specific electronic Tender opening procedures required if electronic Tendering is permitted in accordance with ITT 24.1, shall be as specified in the **TDS**.

27.2 First, envelopes marked "WITHDRAWAL" shall be opened and read out and the envelopes with the corresponding Tender shall not be opened, but returned to the Tenderer. No Tender withdrawal shall be permitted unless the corresponding withdrawal notice contains a valid authorization to request the withdrawal and is read out at Tender opening.

27.3 Next, envelopes marked "SUBSTITUTION" shall be opened and read out and exchanged with the corresponding Tender being substituted, and the substituted Tender shall not be opened, but returned to the Tenderer. No Tender substitution shall be permitted unless the corresponding substitution notice contains a valid authorization to request the substitution and is read out at Tender opening.

27.4 Next, envelopes marked "MODIFICATION" shall be opened and read out with the corresponding Tender. No Tender modification shall be permitted unless the corresponding modification notice contains a valid authorization to request the modification and is read out at Tender opening.

27.5 Next, all remaining envelopes shall be opened one at a time, reading out: the name of the Tenderer and whether there is a modification; the total Tender Price, per lot (contract) if applicable, including any discounts and alternative Tenders; the presence or absence of a Tender Security or Tender-Securing Declaration, if required; and any other details as the Procuring Entity may consider appropriate.

27.6 Only Tenders, alternative Tenders and discounts that are opened and read out at Tender opening shall be considered further for evaluation. The Form of Tender and pages of the Bills of Quantities are to be initialed by the members of the tender opening committee attending the opening. The number of representatives of the Procuring Entity to sign shall be specified in the **TDS**.

27.7 At the Tender Opening, the Procuring Entity shall neither discuss the merits of any Tender nor reject any Tender (except for late Tenders, in accordance with ITT 25.1).

27.8 The Procuring Entity shall prepare minutes of the Tender Opening that shall include, as a minimum:

- a) the name of the Tenderer and whether there is a withdrawal, substitution, or modification;
- b) the Tender Price, per lot (contract) if applicable, including any discounts;
- c) any alternative Tenders;
- d) the presence or absence of a Tender Security, if one was required.

- e) number of pages of each tender document submitted.

27.9 The Tenderers' representatives who are present shall be requested to sign the minutes. The omission of a Tenderer's signature on the minutes shall not invalidate the contents and effect of the minutes. A copy of the tender opening register shall be distributed to all Tenderers upon request.

E Evaluation and Comparison of Tenders

28 Confidentiality

28.1 Information relating to the evaluation of Tenders and recommendation of contract award shall not be disclosed to Tenderers or any other persons not officially concerned with the Tender process until information on Intention to Award the Contract is transmitted to all Tenderers in accordance with ITT 46.

28.2 Any effort by a Tenderer to influence the Procuring Entity in the evaluation of the Tenders or Contract award decisions may result in the rejection of its tender.

28.3 Notwithstanding ITT 28.2, from the time of tender opening to the time of contract award, if a tenderer wishes to contact the Procuring Entity on any matter related to the tendering process, it shall do so in writing.

29 Clarification of Tenders

29.1 To assist in the examination, evaluation, and comparison of the tenders, and qualification of the tenderers, the Procuring Entity may, at its discretion, ask any tenderer for a clarification of its tender, given a reasonable time for a response. Any clarification submitted by a tenderer that is not in response to a request by the Procuring Entity shall not be considered. The Procuring Entity's request for clarification and the response shall be in writing. No change, including any voluntary increase or decrease, in the prices or substance of the tender shall be sought, offered, or permitted, except to confirm the correction of arithmetic errors discovered by the Procuring Entity in the evaluation of the tenders, in accordance with ITT 33.

29.2 If a tenderer does not provide clarifications of its tender by the date and time set in the Procuring Entity's request for clarification, its Tender may be rejected.

30 Deviations, Reservations, and Omissions

30.1 During the evaluation of tenders, the following definitions apply:

- a) "Deviation" is a departure from the requirements specified in the tender document;
- b) "Reservation" is the setting of limiting conditions or withholding from complete acceptance of the requirements specified in the tender document; and
- c) "Omission" is the failure to submit part or all of the information or documentation required in the Tender document.

31 Determination of Responsiveness

31.1 The Procuring Entity's determination of a Tender's responsiveness is to be based on the contents of the tender itself, as defined in ITT 13.

31.2 A substantially responsive Tender is one that meets the requirements of the Tender

document without material deviation, **reservation, or omission. A material deviation, reservation, or omission is one that, if accepted, would:**

- a) affect in any substantial way the scope, quality, or performance of the Works specified in the Contract; or
- b) limit in any substantial way, inconsistent with the tender document, the Procuring Entity's rights or the tenderer's obligations under the proposed contract; or
- c) if rectified, would unfairly affect the competitive position of other tenderers presenting substantially responsive tenders.

31.3 The Procuring Entity shall examine the technical aspects of the tender submitted in accordance with ITT 18, to confirm that all requirements of Section VII, Works' Requirements have been met without any material deviation, reservation or omission.

31.4 If a tender is not substantially responsive to the requirements of the tender document, it shall be rejected by the Procuring Entity and may not subsequently be made responsive by correction of the material deviation, reservation, or omission.

32. Non-material Non-conformities

32.1 Provided that a tender is substantially responsive, the Procuring Entity may waive any non-conformities in the tender.

32.2 Provided that a Tender is substantially responsive, the Procuring Entity may request that the tenderer submit the necessary information or documentation, within a reasonable period, to rectify nonmaterial non-conformities in the tender related to documentation requirements. Requesting information or documentation on such non- conformities shall not be related to any aspect of the price of the tender. Failure of the tenderer to comply with the request may result in the rejection of its tender.

32.3 Provided that a tender is substantially responsive, the Procuring Entity shall rectify quantifiable nonmaterial non-conformities related to the Tender Price. To this effect, the Tender Price shall be adjusted, for comparison purposes only, to reflect the price of a missing or non-conforming item or component in the manner specified in the **TDS**.

33. Arithmetical Errors

33.1 The tender sum as submitted and read out during the tender opening shall be absolute and final and shall not be the subject of correction, adjustment or amendment in any way by any person or entity.

33.2 Provided that the Tender is substantially responsive, the Procuring Entity shall handle errors on the following basis:

- a) Any error detected if considered a major deviation that affects the substance of the tender, shall lead to disqualification of the tender as non- responsive.
- b) Any errors in the submitted tender arising from a miscalculation of unit price, quantity, and subtotal and total bid price shall be considered as a major deviation that affects the substance of the tender and shall lead to disqualification of the tender as non-responsive. and
- c) if there is a discrepancy between words and figures, the amount in words shall prevail

33.3 Tenderers shall be notified of any error detected in their bid during the notification of award.

34. Currency provisions

34.1 Tenders will be priced in Kenya Shillings only. Tenderers quoting in currencies other than in Kenya shillings will be determined non-responsive and rejected.

35. Margin of Preference and Reservations

35.1 No margin of preference shall be allowed on contracts for small works.

35.2 Where it is intended to reserve the contract to specific groups under Small and Medium Enterprises, or enterprise of women, youth and/or persons living with disability, who are appropriately registered as such by the authority to be specified in the **TDS**, a procuring entity shall ensure that the invitation to tender specifically indicates that only businesses/firms belonging to those specified groups are the only ones eligible to tender. Otherwise if no so stated, the invitation will be open to all tenderers.

36. Nominated Subcontractors

36.1 Unless otherwise stated in the **TDS**, the Procuring Entity does not intend to execute any specific elements of the Works by subcontractors selected in advance by the Procuring Entity.

36.2 Tenderers may propose subcontracting up to the percentage of total value of contracts or the volume of works as specified in the **TDS**. Subcontractors proposed by the Tenderer shall be fully qualified for their parts of the Works.

36.3 The subcontractor's qualifications shall not be used by the Tenderer to qualify for the Works unless their specialized parts of the Works were previously designated by the Procuring Entity in the **TDS** as can be met by subcontractors referred to hereafter as 'Specialized Subcontractors', in which case, the qualifications of the Specialized Subcontractors proposed by the Tenderer may be added to the qualifications of the Tenderer.

37. Evaluation of Tenders

37.1 The Procuring Entity shall use the criteria and methodologies listed in this ITT and Section III, Evaluation and Qualification Criteria. No other evaluation criteria or methodologies shall be permitted. By applying the criteria and methodologies the Procuring Entity shall determine the Best Evaluated Tender in accordance with ITT

37.2 To evaluate a Tender, the Procuring Entity shall consider the following:

- a) price adjustment due to discounts offered in accordance with ITT 16;
- b) converting the amount resulting from applying (a) and (b) above, if relevant, to a single currency in accordance with ITT39;
- c) price adjustment due to quantifiable nonmaterial non-conformities in accordance with ITT 30.3; and
- d) any additional evaluation factors specified in the **TDS** and Section III, Evaluation and Qualification Criteria.

37.3 The estimated effect of the price adjustment provisions of the Conditions of Contract, applied over the period of execution of the Contract, shall not be considered in Tender evaluation.

37.4In the case of multiple contracts or lots, Tenderers shall be allowed to tender for one or more lots and the methodology to determine the lowest evaluated cost of the lot (contract) combinations, including any discounts offered in the **Form of Tender**, is specified in **Section III, Evaluation and Qualification Criteria**.

38. Comparison of Tenders

38.1 The Procuring Entity shall compare the evaluated costs of all substantially responsive Tenders established in accordance with ITT 38.2 to determine the Tender that has the lowest evaluated cost.

39. Abnormally Low Tenders

39.1 An Abnormally Low Tender is one where the Tender price, in combination with other elements of the Tender, appears so low that it raises material concerns as to the capability of the Tenderer in regards to the Tenderer's ability to perform the Contract for the offered Tender Price or that genuine competition between Tenderers is compromised.

39.2 In the event of identification of a potentially Abnormally Low Tender, the Procuring Entity shall seek written clarifications from the Tenderer, including detailed price analyses of its Tender price in relation to the subject matter of the contract, scope, proposed methodology, schedule, allocation of risks and responsibilities and any other requirements of the Tender document.

39.3 After evaluation of the price analyses, in the event that the Procuring Entity determines that the Tenderer has failed to demonstrate its capability to perform the Contract for the offered Tender Price, the Procuring Entity shall reject the Tender.

40. Abnormally High Tenders

40.1 An abnormally high price is one where the tender price, in combination with other constituent elements of the Tender, appears unreasonably too high to the extent that the Procuring Entity is concerned that it (the Procuring Entity) may not be getting value for money or it may be paying too high a price for the contract compared with market prices or that genuine competition between Tenderers is compromised.

40.2 In case of an abnormally high tender price, the Procuring Entity shall make a survey of the market prices, check if the estimated cost of the contract is correct and review the Tender Documents to check if the specifications, scope of work and conditions of contract are contributory to the abnormally high tenders. The Procuring Entity may also seek written clarification from the tenderer on the reason for the high tender price. The Procuring Entity shall proceed as follows:

- i) If the tender price is abnormally high based on wrong estimated cost of the contract, the Procuring Entity may accept or not accept the tender depending on the Procuring Entity's budget considerations.
- ii) If specifications, scope of work and/or conditions of contract are contributory to the abnormally high tender prices, the Procuring Entity shall reject all tenders and may retender for the contract based on revised estimates, specifications, scope of work and conditions of contract, as the case may be.

40.3 If the Procuring Entity determines that the Tender Price is abnormally too high because genuine competition between tenderers is compromised (*often due to collusion, corruption or other manipulations*), the Procuring Entity shall reject all Tenders and shall institute or cause competent Government Agencies to institute an investigation on the cause of the compromise, before retendering.

41. Unbalanced and/or Front-Loaded Tenders

41.1 If in the Procuring Entity's opinion, the Tender that is evaluated as the lowest evaluated price is seriously unbalanced and/or front loaded, the Procuring Entity may require the Tender Document-Construction of *Bekibon Water Supply Project in Baringo County* Page 27 of 159

Tenderer to provide written clarifications. Clarifications may include detailed price analyses to demonstrate the consistency of the tender prices with the scope of works, proposed methodology, schedule and any other requirements of the Tender document.

41.2 After the evaluation of the information and detailed price analyses presented by the Tenderer, the Procuring Entity may as appropriate:

- a) accept the Tender; or
- b) require that the total amount of the Performance Security be increased at the expense of the Tenderer to a level not exceeding a 30% of the Contract Price; or
- c) agree on a payment mode that eliminates the inherent risk of the Procuring Entity paying too much for undelivered works; or
- d) reject the Tender,

42. Qualifications of the Tenderer

42.1 The Procuring Entity shall determine to its satisfaction whether the eligible Tenderer that is selected as having submitted the lowest evaluated cost and substantially responsive Tender, meets the qualifying criteria specified in Section III, Evaluation and Qualification Criteria.

42.2 The determination shall be based upon an examination of the documentary evidence of the Tenderer's qualifications submitted by the Tenderer, pursuant to ITT 19. The determination shall not take into consideration the qualifications of other firms such as the Tenderer's subsidiaries, parent entities, affiliates, subcontractors (other than Specialized Subcontractors if permitted in the Tenderdocument), or any other firm(s) different from the Tenderer.

42.3 An affirmative determination shall be a prerequisite for award of the Contract to the Tenderer. A negative determination shall result in disqualification of the Tender, in which event the Procuring Entity shall proceed to the Tenderer who offers a substantially responsive Tender with the next lowest evaluated price to make a similar determination of that Tenderer's qualifications to perform satisfactorily.

42.4 An Abnormally Low Tender is one where the Tender price, in combination with other elements of the Tender, appears so low that it raises material concerns as to the capability of the Tenderer in regards to the Tenderer's ability to perform the Contract for the offered Tender Price.

42.5 In the event of identification of a potentially Abnormally Low Tender, the Procuring Entity shall seek written clarifications from the Tenderer, including detailed price analyses of its Tender price in relation to the subject matter of the contract, scope, proposed methodology, schedule, allocation of risks and responsibilities and any other requirements of the Tender document.

42.6 After evaluation of the price analyses, if the Procuring Entity determines that the Tenderer has failed to demonstrate its capability to perform the Contract for the offered Tender Price, the Procuring Entity shall reject the Tender.

43. Best Evaluated Tender

43.1 Having compared the evaluated prices of Tenders, the Procuring Entity shall determine the Best Evaluated Tender. The Best Evaluated Tender is the Tender of the Tenderer that meets the Qualification Criteria and whose Tender has been determined to be:

- a) Most responsive to the Tender document; and
- b) the lowest evaluated price.

44. Procuring Entity's Right to Accept Any Tender, and to Reject Any or All Tenders.

44.1 The Procuring Entity reserves the right to accept or reject any Tender and to annul the Tender process and reject all Tenders at any time prior to Contract Award, without thereby incurring any liability to Tenderers. In case of annulment, all Tenderers shall be notified with reasons and all Tenders submitted and specifically, Tender securities, shall be promptly returned to the Tenderers.

F. Award of Contract

45. Award Criteria

45.1 The Procuring Entity shall award the Contract to the successful tenderer whose tender has been determined to be the Lowest Evaluated Tender.

46. Notice of Intention to enter into a Contract

- a) Upon award of the contract and Prior to the expiry of the Tender Validity Period the Procuring Entity shall issue a Notification of Intention to Enter into a Contract / Notification of award to all tenderers which shall contain, at a minimum, the following information: the name and address of the Tenderer submitting the successful tender;
- b) the Contract price of the successful tender;
- c) a statement of the reason(s) the tender of the unsuccessful tenderer to whom the letter is addressed was unsuccessful, unless the price information in (c) above already reveals the reason;
- d) the expiry date of the Standstill Period; and
- e) instructions on how to request a debriefing and/or submit a complaint during the standstill period;

47. Standstill Period

47.1 The Contract shall not be signed earlier than the expiry of a Standstill Period of 14 days to allow any dissatisfied tender to launch a complaint. Where only one Tender is submitted, the Standstill Period shall not apply.

47.2 Where a Standstill Period applies, it shall commence when the Procuring Entity has transmitted to each Tenderer the Notification of Intention to Enter **into a Contract with the successful Tenderer.**

48. Debriefing by the Procuring Entity

48.1 On receipt of the Procuring Entity's Notification of Intention to Enter into a Contract referred to in ITT 46, an unsuccessful tenderer may make a written request to the Procuring Entity for a debriefing on specific issues or concerns regarding their tender. The Procuring Entity shall provide the debriefing within five days of receipt of the request.

48.2 Debriefings of unsuccessful Tenderers may be done in writing or verbally. The Tenderer shall bear its own costs of attending **such a debriefing meeting.**

49. Letter of Award

49.1 Prior to the expiry of the Tender Validity Period and upon expiry of the Standstill Period specified in ITT 42.1, upon addressing a complaint that has been filed within the Standstill Period, the Procuring Entity shall transmit the Letter of Award to the successful Tenderer. The letter of award shall request the successful tenderer to furnish the Performance Security within 21 days of the date of the letter.

50. Signing of Contract

50.1 Upon the expiry of the fourteen days of the Notification of Intention to enter into contract and upon the parties meeting their respective statutory requirements, the Procuring Entity shall send the successful Tenderer the Contract Agreement.

50.2 Within fourteen (14) days of receipt of the Contract Agreement, the successful Tenderer shall sign, date, and return it to the Procuring Entity.

50.3 The written contract shall be entered into within the period specified in the notification of award and before expiry of the tender validity period

51. Appointment of Adjudicator

51.1 The Procuring Entity proposes the person named in the **TDS** to be appointed as Adjudicator under the Contract, at the hourly fee specified in the **TDS**, plus reimbursable expenses. If the Tenderer disagrees with this proposal, the Tenderer should so state in his Tender. If, in the Letter of Acceptance, the Procuring Entity does not agree on the appointment of the Adjudicator, the Procuring Entity will request the Appointing Authority designated in the Special Conditions of Contract (SCC) pursuant to Clause 23.1 of the General Conditions of Contract (GCC), to appoint the Adjudicator.

52. Performance Security

52.1 Within twenty-one (21) days of the receipt of the Letter of Acceptance from the Procuring Entity, the successful Tenderer shall furnish the Performance Security and, any other documents required in the **TDS**, in accordance with the General Conditions of Contract, subject to ITT 40.2 (b), using the Performance Security and other Forms included in Section X, Contract Forms, or another form acceptable to the Procuring Entity. A foreign institution providing a bank guarantee shall have a correspondent financial institution located in Kenya, unless the Procuring Entity has agreed in writing that a correspondent bank is not required.

52.2 Failure of the successful Tenderer to submit the above-mentioned Performance Security and other documents required in the **TDS**, or sign the Contract shall constitute sufficient grounds for the annulment of the award and forfeiture of the Tender Security. In that event the Procuring Entity may award the Contract to the Tenderer offering the next Best Evaluated Tender.

52.3 Performance security shall not be required for contracts estimated to cost less than Kenya shillings five million shillings.

53. Publication of Procurement Contract

53.1 Within fourteen days after signing the contract, the Procuring Entity shall publish the awarded contract at its notice boards and websites; and on the Website of the Authority. At the minimum, the notice shall contain the following information:

- a) name and address of the Procuring Entity;
- b) name and reference number of the contract being awarded, a summary of its scope and the selection method used;
- c) the name of the successful Tenderer, the final total contract price, the contract duration.
- d) dates of signature, commencement and completion of contract;
- e) names of all Tenderers that submitted Tenders, and their Tender prices as read out at Tender opening.

54. Procurement Related Complaints and Administrative Review

54.1 The procedures for making Procurement-related Complaints are as specified in the **TDS**.

54.2 A request for administrative review shall be made in the form provided under contract forms.

Fairness, Transparency & Accountability

SECTION II - TENDER DATA SHEET (TDS)

The following specific data shall complement, supplement, or amend the provisions in the Instructions to Tenderers (ITT). Whenever there is a conflict, the provisions herein shall prevail over those in ITT.

ITT Reference	PARTICULARS OF APPENDIX TO INSTRUCTIONS TO TENDERS
	A. General
ITT 1.1	The name of the contract is Construction of Bekibon Water Supply Project in Baringo County The reference number of the Contract is CRVWWDA/BAR/BEK/WSP/GOK/42/2023-2024
ITT 2.3	The project is financed by The Government of Kenya The Procuring entity is Central Rift Valley Water Works Development Agency The Financial Year of project implementation is 2023/24 Financial Year Works under the contract include but NOT limited to the following: <ol style="list-style-type: none"> 1. Construction of intake 2. Gravity and Rising mains 3. Pumping system 4. Masonry Tanks
ITT 2.4	The firms that provided consulting services for the contract being tendered for are: N/A
ITT 3.1	Maximum number of members in the Joint Venture (JV) shall be: 2
	B. Contents of Tender Document
8.1	The Pre-bid site visit is scheduled for 10:00am 13th March 2024 at Bekibon Chief's Office, Baringo South Sub-County, Baringo County
ITT 8.2	The Tenderer will submit any questions in writing, to reach the Procuring Entity not later than 7 days to closing of tender
ITT 8.4	NOT APPLICABLE
ITT 9.1	For clarification of tender process only the Procuring Entity's address is The Chief Executive Officer, Central Rift Valley Water Works Development Agency P.O Box 2451-20100, Nakuru, Physical address: Maji Plaza, Prisons Road Telephone: 0725999000 Electronic mail address: info@crvwwda.go.ke/ cc:procurement@crvwwda.go.ke Web page. www.crvwwda.go.ke
	C. Preparation of Tenders
ITP 13.1 (h)	The tenderer shall submit the following additional documents amongst any other as indicated in its tender <ol style="list-style-type: none"> a) Copies of original documents defining the constitution or legal status, place of registration, and principal, place of business including: <ol style="list-style-type: none"> i) Valid VAT/KRA PIN certificate. ii) Valid Registration certificate. iii) Valid Tax compliant certificate b) Written power of attorney to authorize the signatory of the Tender to commit the Tenderer.

ITT Reference	PARTICULARS OF APPENDIX TO INSTRUCTIONS TO TENDERS
	c) Registration as Civil Engineering Contractors (Water Works) minimum of Class NCA 7 or above with the National Construction Authority of Kenya. (Valid NCA certificate) d) Certified copy of CR 12 Form indicating Directorship of Company. e) Submission of audited books of accounts for the last three (3) years.
ITT 15.1	Alternative Tenders <i>shall not be</i> considered.
ITT 15.2	Alternative times for completion <i>shall not be</i> permitted.
ITT 15.4	N/A
ITT 16.5	The prices quoted by the Tenderer shall be: FIXED
ITT 20.1	The Tender validity period shall be 120 days.
ITT 21.1	A Tender-Securing Declaration <i>shall be required</i> .
ITT 22.1	In addition to the original of the Tender, the Tenderer should submit 1 copy (i.e. Original and a copy) of the Tender <i>It is mandatory requirement to serialize each of the pages of the Bid.</i>
ITT 22.3	The written confirmation of authorization to sign on behalf of the Tenderer shall consist of: <i>The power of attorney. Issued by registered Directors or licensed commissioner of oaths.</i>
D. Submission and Opening of Tenders	
ITT 24.1	<p style="text-align: center;"> Chief Executive Officer Central Rift Valley Water Works Development Agency Maji Plaza, Prisons Road P.O. Box 2451-20100 Nakuru, Kenya Mobile No. 0725999000 E-mail: info@crvwwda.go.ke </p> <p>Date and time for submission of Tenders: 27th March 2024 Time: 1200hrs</p> <p>Tenderers shall not submit tenders electronically.</p>
ITT 27.1	The Tender opening shall take place at the time and the address for Opening of Tenders provided below: (1) Central Rift Valley Water Works Development Agency <i>Maji Plaza, Prisons Road P.O Box 2451 Nakuru</i> (2) Time of tender opening. Day: 27TH MARCH 2024 Time: 1205hrs
ITT 27.1	N/A
ITT 27.6	The number of representatives of the Procuring Entity to sign is: ONE
E. Evaluation, and Comparison of Tenders	
ITT 32.3	NOT APPLICABLE
ITT 35.2	The invitation to tender is extended to the following group that qualify for Reservations _____ N/A _____
ITT 36.1	At this time, CRVWWDA <i>does not intend</i> to execute any specific parts of the Works by subcontractors selected in advance.

ITT Reference	PARTICULARS OF APPENDIX TO INSTRUCTIONS TO TENDERS
ITT 36.2	Contractor's may propose subcontracting: Maximum percentage of subcontracting permitted is: <u>N/A</u> % of the total contract amount. Tenderers planning to subcontract more than 10% of total volume of work shall specify, in the Form of Tender, the activity (ies) or parts of the Works to be subcontracted along with complete details of the subcontractors and their qualification and experience: N/A
ITT 36.3	NOT APPLICABLE
ITT 37.2 (d)	Additional requirements apply. These are detailed in the evaluation criteria in Section III, Evaluation and Qualification Criteria.
ITT 51.1	NOT APPLICABLE
ITT 54.1	<p>For the attention:</p> <p>Title/position: THE CHIEF EXECUTIVE OFFICER</p> <p>Procuring Entity: CENTRAL RIFT VALLEY WATER WORKS DEVELOPMENT AGENCY</p> <p>Email address: info@crvwvda.go.ke / procurement@crvwvda.go.ke</p>

SECTION III - EVALUATION AND QUALIFICATION CRITERIA

1. General Provisions

Wherever a Tenderer is required to state a monetary amount, Tenderers should indicate the Kenya Shilling equivalent using the rate of exchange determined as follows:

- a) For construction turnover or financial data required for each year - Exchange rate prevailing on the last day of the respective calendar year (in which the amounts for that year is to be converted) was originally established.
- b) Value of single contract - Exchange rate prevailing on the date of the contract signature.
- c) Exchange rates shall be taken from the publicly available source identified in the ITT 14.3. Any error in determining the exchange rates in the Tender may be corrected by the Procuring Entity.

This section contains the criteria that the Employer shall use to evaluate tender and qualify tenderers. No other factors, methods or criteria shall be used other than specified in this tender document. The Tenderer shall provide all the information requested in the forms included in Section IV, Tendering Forms. The Procuring Entity should use **The Standard Tender Evaluation Document for Goods and Works** for evaluating Tenders.

Evaluation and contract award Criteria

The Procuring Entity shall use the criteria and methodologies listed in this Section to evaluate tenders and arrive at the Lowest Evaluated Tender. The tender that (i) meets the qualification criteria, (ii) has been determined to be substantially responsive to the Tender Documents, and (iii) is determined to have the Lowest Evaluated Tender price shall be selected for award of contract.

2. Preliminary examination for Determination of Responsiveness

The Procuring Entity will start by examining all tenders to ensure they meet in all respects the eligibility criteria and other requirements in the ITT, and that the tender is complete in all aspects in meeting the requirements of “Part 2 – Procuring Entity's Works Requirements”, including checking for tenders with unacceptable errors, abnormally low tenders, abnormally high tenders and tenders that are front loaded. The Standard Tender Evaluation Report Document for Goods and Works for evaluating Tenders provides very clear guide on how to deal with review of these requirements. Tenders that do not pass the Preliminary Examination will be considered irresponsive and will not be considered further.

Preliminary Evaluation (Any other requirement as outlined in the qualification form summary or bid document)

Preliminary evaluation and Mandatory requirements				
	NO	MANDATORY REQUIREMENTS (bidders must provide all this)	YES	NO
	1.	Must submit a copy of valid Certificate of Incorporation		
	2.	Certificate of Confirmation of Directors and shareholding (CR12)		
	3.	Must submit a dully filled, signed, and stamped Tender Securing Declaration Form		
	4.	Must submit a copy of valid Tax Compliance Certificate from KRA		
	5.	Sequential Pagination of the entire document		
	6.	Must fill the price schedule/BOQ in the format provided where applicable (<i>Rates inclusive of VAT and any other taxes</i>)		
	7.	Must fill the form of tender in the format provided and instructions provided		
	8.	Must submit a duly filled up confidential business questionnaire in the format provided		
	9.	Must fill the anti-corruption in the format provided		
	10.	Must fill the debarment form in the format provided		
	11.	Must fill the Code of ethics form		
	12.	Must fill the Tenderers information form		
	13.	Notarized Power of Attorney.		
	14.	Registration by relevant regulatory authority (Valid NCA certificate. (Registration as Civil Engineering Contractors (Water Works) minimum of Class NCA 7)		
	15.	Must Provide Valid Access to Government Procurement Opportunities (AGPO) registration certificate for either Youth, Women or PWD		
		<p><i>At this stage, the tenderers submission will either be responsive or non- responsive. The non- responsive submission will be eliminated from the entire evaluation process and will not be considered further.</i></p> <p><i>NB: Bidders are also informed to organize their evidentiary documentation in the order above for ease of reference.</i></p>		

Technical evaluation

The detailed evaluation requirements is tabulated below

Technical Evaluation

Item	Description		
1.	<u>Key Personnel (<i>Attach evidence</i>)</u>	Compliance requirement	Documentation required
	(i) Site Agent 1No At least Diploma in a Civil/water engineering or equivalent. with 5 years relevant experience	Must meet requirements	<ul style="list-style-type: none"> • Appointment letter/proof of Commitment and availability by personnel for duration of assignment • Copies of academic certificates • Up to Date CV with evidence of undertaking similar works
	(ii) Foreman;1No At least Diploma in a Civil/water engineering or equivalent. with 5 years relevant experience	Must meet requirements	<ul style="list-style-type: none"> • Appointment letter/proof of Commitment and availability by personnel for duration of assignment • Copies of academic certificates • Up to Date CV with evidence of undertaking similar works
	(iii) Plumber;1 No At least trade test, grade III or equivalent in plant operation with 3years relevant experience	Must meet requirements	<ul style="list-style-type: none"> • Appointment letter/proof of Commitment and availability by personnel for duration of assignment • Copies of academic certificates • Up to Date CV with evidence of undertaking similar works
2	<u>Equipment detail</u>	Compliance requirement	Documentation required
	i. Support Truck/Lorry (1 No.)	Must meet requirements	<ul style="list-style-type: none"> • (Log book or lease/hire agreements must be attached specifying the registration or serial numbers) <i>(The leased/hired equipment validity period should exceed at least one year from the date submission)</i>
3.	<u>General Construction Experience</u> Experience under construction contracts in the role of prime contractor, JV member, sub-contractor, or management contractor for at least the last Three [3] years prior to the applications submission deadline, and with activity in at least (6) months in each year	Must meet requirements	<ul style="list-style-type: none"> • Notification of award with corresponding certificate of practical completion • Copies of LSOs with corresponding certificate of practical completion • Copies of Duly signed, stamped Contract of works with corresponding certificate of practical completion
4.	<u>Specific Construction & Contract Management Experience</u> A minimum number of <i>one</i> similar contract specified below that have been satisfactorily and substantially completed as a prime contractor, joint venture member, management contractor or sub-contractor between 27th March 2021 and tender submission deadline i.e., 27th March 2024 (number) contracts, each of minimum value Kenya shillings 10,000,000.00 The similarity of the contracts shall be based on the following: <ul style="list-style-type: none"> • Construction of a Water Supply project <i>with cumulative contract value of not less than 10M for each project</i> 	Must meet requirements	<ul style="list-style-type: none"> • Notification of award with corresponding certificate of practical completion • Copies of LSOs with corresponding certificate of practical completion • Copies of Duly signed, stamped Contract of works with corresponding certificate of practical completion

5.	<u>Financial Capability</u> i) The minimum required annual volume of construction work for the successful Tenderer in the last 3 years shall be: Ksh. 25 million Kenya Shillings. ii) Bidder to submit audited accounts for the last 3 years iii) Demonstrate access to, or availability of, financial resources such as liquid assets, lines of credit, and other financial means, other than any contractual advance payments to meet cash flow of Ksh 5,000,000 or equivalent in a freely convertible currency, and the overall cash requirements for this contract and its concurrent commitments	Must meet requirements	Audited financial statements for the last 3 years Letters from banks affirming availability of credit facilities should be dully signed and stamped by the authorized officers.
6.	<u>History of Non-Performing Contracts</u> Non-performance of a contract did not occur as a result of contractor default	Must meet requirements	Form CON-2
7.	<u>Pending Litigation</u> Tender's financial position and prospective long-term profitability still sound according to criteria established in 3.1 and assuming that all pending litigation will NOT be resolved against the Tenderer.	Must meet requirements	Form CON – 2
8.	<u>Litigation History</u> No consistent history of court/arbitral award decisions against the Tenderer	Must meet requirements	Form CON – 2

Only bidders who qualify at this stage will be subjected to the award criteria. Financial comparison which will be in accordance to Section 82, PPADA 2015

FINANCIAL EVALUATION

Bids that pass the Technical Evaluation shall be subjected to Financial Evaluation.

NOTE

1. **The procuring entity reserves the right to carry out due diligence on the responsive tenders prior to award of the contract.**
2. **Any false information provided by a bidder shall lead to automatic disqualification.**

Tender Evaluation (ITT 35) Price evaluation:

In addition to the criteria listed in ITT 35.2 (a) – (c) the following criteria shall apply:

- i) **Alternative Completion Times**, if permitted under ITT 13.2, will be evaluated as follows:
Not Applicable
- ii) **Alternative Technical Solutions** for specified parts of the Works, if permitted under ITT 13.4, will be evaluated as follows:**Not Applicable**
- iii) **Other Criteria**; if permitted under ITT 35.2(d):
Not Applicable

3. **Multiple Contracts/ Not Applicable**

Multiple contracts will be permitted in accordance with ITT 35.4. Tenderers are evaluated on basis of Lots and the lowest evaluated tenderer identified for each Lot. The Procuring Entity will select one Option of the two Options listed below for award of Contracts.

OPTION 1

- i) If a tenderer wins only one Lot, the tenderer will be awarded a contract for that Lot, provided the tenderer meets the Eligibility and Qualification Criteria for that Lot.
- ii) If a tenderer wins more than one Lot, the tenderer will be awarded contracts for all won Lots, provided the tenderer meets the aggregate Eligibility and Qualification Criteria for all the Lots. The tenderer will be awarded the combination of Lots for which the tenderer qualifies and the others will be considered for award to second lowest the tenderers.

OPTION 2

The Procuring Entity will consider all possible combinations of won Lots [contract(s)] and determine the combinations with the lowest evaluated price. Tenders will then be awarded to the Tenderer or Tenderers in the combinations provided the tenderer meets the aggregate Eligibility and Qualification Criteria for all the won Lots.

4. Alternative Tenders (ITT 13.1): Not Applicable

An alternative if permitted under ITT 13.1, will be evaluated as follows:

The Procuring Entity shall consider Tenders offered for alternatives as specified in Part 2- Works Requirements. Only the technical alternatives, if any, of the Tenderer with the Best Evaluated Tender conforming to the basic technical requirements shall be considered by the Procuring Entity.

5. Margin of Preference is not applicable

6. Technical Qualification criteria

7. Technical Qualification criteria

- a) The minimum required annual volume of construction work for the successful Tenderer in any of the last 3 years shall be: **Ksh 25,000,000(Twenty-Five Million)**
- b) Experience as prime contractor in the construction of at **least 1 (1) project of a nature and complexity** equivalent to the Works in the last 3 years or the period stated above to comply with this requirement, works cited should be at least 80 percent complete. **History of performance for bidders who have worked with the Agency shall be considered)**
- c) Experience under contracts in the role of contractor, subcontractor, or management contractor for at least the last three (3) years prior to the application submission deadline and with activity in at least (6) months in each year.
- d) Participation as a contractor, subcontractor, or management contractor in at least **one (1) contract** within the last three (3) years with a value of **at least Ksh 10,000,000(Ten million)**, or equivalent in a freely convertible currency, that have been successfully and substantially completed and that are similar to the proposed works. The similarity shall be based on the physical size, complexity, method/technology or other characteristics as described as Employer's requirements as below:
- e) **The essential equipment to be made available for the Contract by the successful Tenderer** (Log book or lease/hire agreements must be attached specifying the registration or serial numbers) shall be:

Equipment Detail	Minimum required number
Lorry	1

- i) Other conditions depending on their seriousness.
- a) **History of non-performing contracts:**
Tenderer and each member of JV in case the Tenderer is a JV, shall demonstrate that Non- performance of a contract did not occur because of the default of the Tenderer, or the member of a JV in the last 3 years The required information shall be furnished in the appropriate form.
- b) **Pending Litigation**
Financial position and prospective long-term profitability of the Single Tenderer, and in the case the Tenderer is a JV, of each member of the JV, shall remain sound according to criteria established with respect to Financial Capability under Paragraph
(i) above if all pending litigation will be resolved against the Tenderer. Tenderer shall provide information on pending litigations in the appropriate form.
- c) **Litigation History**
There shall be no consistent history of court/arbitral award decisions against the Tenderer, in the last 3 years All parties to the contract shall furnish the information in the appropriate form about any litigation or arbitration resulting from contracts completed or ongoing under its execution over the years specified. A consistent history of awards against the Tenderer or any member of a JV may result in rejection of the tender.

8. QUALIFICATION FORM SUMMARY

1 Item No.	2 Qualification Subject	3 Qualification Requirement	4 Document To be Completed/Provided by Tenderer/	5 For Procuring Entity's Use (Qualification met or Not Met)
1.	Nationality	Nationality in accordance with ITT 3.6	Forms ELI – 1.1 and 1.2, with attachments	
2.	Tax Obligations for Kenyan Tenderers	Has produced a current tax clearance certificate or tax exemption certificate issued by the Kenya Revenue Authority in accordance with ITT 3.14.	Form of Tender	
3.	Conflict of Interest	No conflicts of interest in accordance with ITT 3.3	Form of Tender	
4.	PPRA Eligibility	Not having been declared ineligible by the PPRA as described in ITT 3.8	Form of Tender	
5.	State- owned Enterprise	Meets conditions of ITT 3.7	Forms ELI – 1.1 and 1.2, with attachments	
6.	Goods, equipment and services to be supplied under the contract	To have their origin in any country that is not determined ineligible under ITT 4.1	Forms ELI – 1.1 and 1.2, with attachments	
7.	History of Non-Performing Contracts	Non-performance of a contract did not occur as a result of contractor default	Form CON-2	
8.	Suspension Based on Execution of Tender/Proposal Securing Declaration by the Procuring Entity	Not under suspension based on-execution of a Tender/Proposal Securing Declaration pursuant to ITT 19.9	Form of Tender	
9.	Pending Litigation	Tender's financial position and prospective long-term profitability still sound according to criteria established in 3.1 and assuming that all pending litigation will NOT be resolved against the Tenderer.	Form CON – 2	
10.	Litigation History	No consistent history of court/arbitral award decisions against the Tenderer	Form CON – 2	
11.	Financial Capabilities	(i) The Tenderer shall demonstrate that it has access to, or has available, liquid assets, unencumbered real assets, lines of credit, and other financial means (independent of any contractual advance payment) sufficient to meet the construction cash flow requirements estimated as Kenya Shillings 5,000,000/= equivalent for the subject contract(s) net of the Tenderer's other commitments. (ii) The Tenderers shall also demonstrate, to the satisfaction of the	Form FIN – 3.1, with attachments	

		<p>Procuring Entity, that it has adequate sources of finance to meet the cash flow requirements on works currently in progress and for future contract commitments.</p> <p>(iii) The audited balance sheets or, if not required by the laws of the Tenderer's country, other financial statements acceptable to the Procuring Entity, for the last three years shall be submitted and must demonstrate the current soundness of the Tenderer's financial position and indicate its prospective long-term profitability.</p>		
12.	Average Annual Construction Turnover	Minimum average annual construction turnover of Kenya Shillings 25,000,000.00 equivalent calculated as total certified payments received for contracts in progress and/or completed within the last three years, divided by [insert number of years] years	Form FIN – 3.2	
13.	General Construction Experience	Experience under construction contracts in the role of prime contractor, JV member, sub-contractor, or management contractor for at least the last three years	Form EXP – 4.1	
14.	Specific Construction & Contract Management Experience	<p>A minimum number of one similar contract specified below that have been satisfactorily and substantially completed as a prime contractor, joint venture member, management contractor or sub-contractor between 27th March 2021 and tender submission deadline i.e. 27th March 2024 (number) contracts, each of minimum value Kenya shillings 10,000,000.00 equivalent.</p> <p><i>[In case the Works are to be tender as individual contracts under multiple contract procedure, the minimum number of contracts required for purposes of evaluating qualification shall be selected from the options mentioned in ITT 35.4]</i></p> <p>The similarity of the contracts shall be based on the following: <i>[Based on Section VII, Scope of Works, specify the minimum key requirements in terms of physical size, complexity, construction method, technology and/or other characteristics including part of the requirements that may be met by specialized subcontractors, if permitted in accordance with ITT 34.3]</i></p>	Form EXP 4.2(a)	

QUALIFICATION FORMS

(Bidders must fill this form and provide accompanying document of ownership)

1. FORMEQU: EQUIPMENT

The Tenderer shall provide adequate information to demonstrate clearly that it has the capability to meet the requirements for the key equipment listed in Section III, Evaluation and Qualification Criteria. A separate Form shall be prepared for each item of equipment listed, or for alternative equipment proposed by the Tenderer.

Item of equipment		
Equipment information	Name of manufacturer	Model and power rating
	Capacity	Year of manufacture
Current status	Current location	
	Details of current commitments	
Source	Indicate source of the equipment <input type="checkbox"/> Owned <input type="checkbox"/> Rented <input type="checkbox"/> Leased <input type="checkbox"/> Specially manufactured	

Omit the following information for equipment owned by the Tenderer.

Owner	Name of owner	
	Address of owner	
	Telephone	Contact name and title
	Fax	Telex
Agreements	Details of rental / lease / manufacture agreements specific to the project	

2 FORM PER-1

Contractor's Representative and Key Personnel Schedule

Tenderers should provide the names and details of the suitably qualified Contractor's Representative and Key Personnel to perform the Contract. The data on their experience should be supplied using the Form PER-2 below for each candidate.

Contractor' Representative and Key Personnel

1.	Title of position: Contractor's Representative	
	Name of candidate:	
	Duration of appointment:	<i>[insert the whole period (start and end dates) for which this position will be engaged]</i>
	Time commitment: for this position:	<i>[insert the number of days/week/months/ that has been scheduled for this position]</i>
	Expected time schedule for this position:	<i>[insert the expected time schedule for this position (e.g. attach high level Gantt chart)]</i>
2.	Title of position: [_____]	
	Name of candidate:	
	Duration of appointment:	<i>[insert the whole period (start and end dates) for which this position will be engaged]</i>
	Time commitment: for this position:	<i>[insert the number of days/week/months/ that has been scheduled for this position]</i>
	Expected time schedule for this position:	<i>[insert the expected time schedule for this position (e.g. attach high level Gantt chart)]</i>
3.	Title of position: [_____]	
	Name of candidate:	
	Duration of appointment:	<i>[insert the whole period (start and end dates) for which this position will be engaged]</i>
	Time commitment: for this position:	<i>[insert the number of days/week/months/ that has been scheduled for this position]</i>
	Expected time schedule for this position:	<i>[insert the expected time schedule for this position (e.g. attach high level Gantt chart)]</i>
4.	Title of position: [_____]	
	Name of candidate:	
	Duration of appointment:	<i>[insert the whole period (start and end dates) for which this position will be engaged]</i>
	Time commitment: for this position:	<i>[insert the number of days/week/months/ that has been scheduled for this position]</i>
	Expected time schedule for this position:	<i>[insert the expected time schedule for this position (e.g. attach high level Gantt chart)]</i>
5.	Title of position: [insert title]	
	Name of candidate	
	Duration of appointment:	<i>[insert the whole period (start and end dates) for which this position will be engaged]</i>
	Time commitment: for this position:	<i>[insert the number of days/week/months/ that has been scheduled for this position]</i>
	Expected time schedule for this position:	<i>[insert the expected time schedule for this position (e.g. attach high level Gantt chart)]</i>

3. FORM PER-2:

Resume and Declaration - Contractor's Representative and Key Personnel.

Summarize professional experience in reverse chronological order. Indicate particular technical and managerial experience relevant to the project.

Name of Tenderer		
Position [#I]: [title of position from Form PER-1]		
Personnel information	Name:	Date of birth:
	Address:	E-mail:
	Professional qualifications:	
	Academic qualifications:	
	Language proficiency: [language and levels of speaking, reading and writing skills]	
Details	Address of Procuring Entity:	
	Telephone:	Contact (manager / personnel officer):
	Fax:	
	Job title:	Years with present Procuring Entity:

Summarize professional experience in reverse chronological order. Indicate particular technical and managerial experience relevant to the project.

Project	Role	Duration of involvement	Relevant experience
[main project details]	[role and responsibilities on the project]	[time in role]	[describe the experience relevant to this position]

Declaration

I, the undersigned [*insert either "Contractor's Representative" or "Key Personnel" as applicable*], certify that to the best of my knowledge and belief, the information contained in this Form PER-2 correctly describes myself, my qualifications and my experience.

I confirm that I am available as certified in the following table and throughout the expected time schedule for this position as provided in the Tender:

Commitment	Details
Commitment to duration of contract:	<i>[insert period (start and end dates) for which this Contractor's Representative or Key Personnel is available to work on this contract]</i>
Time commitment:	<i>[insert period (start and end dates) for which this Contractor's Representative or Key Personnel is available to work on this contract]</i>

I understand that any misrepresentation or omission in this Form may:

- a) be taken into consideration during Tender evaluation;
- b) result in my disqualification from participating in the Tender;
- c) result in my dismissal from the contract.

Name of Contractor's Representative or Key Personnel: [*insert name*]

Signature: _____

Date: (day month year): _____

Countersignature of authorized representative of the Tenderer:

Signature: _____ Date: (day month year): _____

4 TENDERER'S QUALIFICATION WITHOUT PRE-QUALIFICATION

To establish its qualifications to perform the contract in accordance with Section III, Evaluation and Qualification Criteria the Tenderer shall provide the information requested in the corresponding Information Sheets included hereunder.

4.1 FORM ELI -1.1

Tenderer Information Form

Date: _____

ITT No. and title: _____

Tenderer's name
In case of Joint Venture (JV), name of each member:
Tenderer's actual or intended country of registration: <i>[indicate country of Constitution]</i>
Tenderer's actual or intended year of incorporation:
Tenderer's legal address [in country of registration]:
Tenderer's authorized representative information Name: _____ Address: _____ Telephone/Fax numbers: _____ E-mail address: _____
1. Attached are copies of original documents of <input type="checkbox"/> Articles of Incorporation (or equivalent documents of constitution or association), and/or documents of registration of the legal entity named above, in accordance with ITT 3.6 <input type="checkbox"/> In case of JV, letter of intent to form JV or JV agreement, in accordance with ITT 3.5 <input type="checkbox"/> In case of state-owned enterprise or institution, in accordance with ITT 3.8, documents establishing: <ul style="list-style-type: none"> • Legal and financial autonomy • Operation under commercial law • Establishing that the Tenderer is not under the supervision of the Procuring Entity
2. Included are the organizational chart, a list of Board of Directors, and the beneficial ownership.

4.2 FORM ELI -1.2

**Tenderer's JV Information Form
(to be completed for each member of Tenderer's JV)**

Date: _____

ITT No. and title: _____

Tenderer's JV name:
JV member's name:
JV member's country of registration:
JV member's year of constitution:
JV member's legal address in country of constitution:
JV member's authorized representative information Name: _____ Address: _____ Telephone/Fax numbers: _____ E-mail address: _____
1. Attached are copies of original documents of <input type="checkbox"/> Articles of Incorporation (or equivalent documents of constitution or association), and/or registration documents of the legal entity named above, in accordance with ITT 3.6. <input type="checkbox"/> In case of a state-owned enterprise or institution, documents establishing legal and financial autonomy, operation in accordance with commercial law, and that they are not under the supervision of the Procuring Entity, in accordance with ITT 3.8.
2. Included are the organizational chart, a list of Board of Directors, and the beneficial ownership.

4.3 FORM CON – 2

Historical Contract Non-Performance, Pending Litigation and Litigation History

Tenderer's Name: _____

Date: _____

JV Member's Name _____

ITT No. and title: _____

Non-Performed Contracts in accordance with Section III, Evaluation and Qualification Criteria			
<input type="checkbox"/> Contract non-performance did not occur since 27th March 2021 <i>specified</i> in Section III, Evaluation and Qualification Criteria, Sub-Factor 2.1.			
<input type="checkbox"/> Contract(s) not performed since 27TH MARCH 2024 <i>specified</i> in Section III, Evaluation and Qualification Criteria, requirement 2.1			
Year	Non- performed portion of contract	Contract Identification	Total Contract Amount (current value, currency, exchange rate and Kenya Shilling equivalent)
<i>[insert year]</i>	<i>[insert amount and percentage]</i>	Contract Identification: <i>[indicate complete contract name/ number, and any other identification]</i> Name of Procuring Entity: <i>[insert full name]</i> Address of Procuring Entity: <i>[insert street/city/country]</i> Reason(s) for nonperformance: <i>[indicate main reason(s)]</i>	<i>[insert amount]</i>
Pending Litigation, in accordance with Section III, Evaluation and Qualification Criteria			
<input type="checkbox"/> No pending litigation in accordance with Section III, Evaluation and Qualification Criteria, Sub-Factor 2.3.			
<input type="checkbox"/> Pending litigation in accordance with Section III, Evaluation and Qualification Criteria, Sub-Factor 2.3 as indicated below.			

Year of dispute	Amount in dispute (currency)	Contract Identification	Total Contract Amount (currency), Kenya Shilling Equivalent (exchange rate)
		Contract Identification: _____ Name of Procuring Entity: _____ Address of Procuring Entity: _____ Matter in dispute: _____ Party who initiated the dispute: _____ Status of dispute: _____	
		Contract Identification: Name of Procuring Entity: Address of Procuring Entity: Matter in dispute: Party who initiated the dispute: Status of dispute:	
Litigation History in accordance with Section III, Evaluation and Qualification Criteria			
<input type="checkbox"/> No Litigation History in accordance with Section III, Evaluation and Qualification Criteria, Sub-Factor 2.4.			
<input type="checkbox"/> Litigation History in accordance with Section III, Evaluation and Qualification Criteria, Sub-Factor 2.4			

as indicated below.

Year of award	Outcome as percentage of Net Worth	Contract Identification	Total Contract Amount (currency), Kenya Shilling Equivalent (exchange rate)
<i>[insert year]</i>	<i>[insert percentage]</i>	Contract Identification: [indicate complete contract name, number, and any other identification] Name of Procuring Entity: <i>[insert full name]</i> Address of Procuring Entity: <i>[insert street/city/country]</i> Matter in dispute: <i>[indicate main issues in dispute]</i> Party who initiated the dispute: <i>[indicate "Procuring Entity" or "Contractor"]</i> Reason(s) for Litigation and award decision <i>[indicate main reason(s)]</i>	<i>[insert amount]</i>

4.4 FORM FIN – 3.1:

Financial Situation and Performance

Tenderer's Name: _____
 Date: _____
 JV Member's Name _____
 ITT No. and title: _____

4.4.1. Financial Data

Type of Financial information in _____ (currency)	Historic information for previous _____ years, (amount in currency, currency, exchange rate*, USD equivalent)				
	Year 1	Year 2	Year 3	Year 4	Year 5
Statement of Financial Position (Information from Balance Sheet)					
Total Assets (TA)					
Total Liabilities (TL)					
Total Equity/Net Worth (NW)					
Current Assets (CA)					
Current Liabilities (CL)					
Working Capital (WC)					
Information from Income Statement					

Type of Financial information in (currency)	Historic information for previous _____ years, (amount in currency, currency, exchange rate*, USD equivalent)				
	Year 1	Year 2	Year 3	Year 4	Year 5
Total Revenue (TR)					
Profits Before Taxes (PBT)					
Cash Flow Information					
Cash Flow from Operating Activities					

*Refer to ITT 15 for the exchange rate

4.4.2 Sources of Finance

Specify sources of finance to meet the cash flow requirements on works currently in progress and for future contract commitments.

No.	Source of finance	Amount (Kenya Shilling equivalent)
1		
2		
3		

4.4.3 Financial documents

The Tenderer and its parties shall provide copies of financial statements for _____ years pursuant Section III, Evaluation and Qualifications Criteria, Sub-factor 3.1. The financial statements shall:

- (a) reflect the financial situation of the Tenderer or in case of JV member, and not an affiliated entity (such as parent company or group member).
- (b) be independently audited or certified in accordance with local legislation.
- (c) be complete, including all notes to the financial statements.
- (d) correspond to accounting periods already completed and audited.

Attached are copies of financial statements¹ for the _____ years required above; and complying with the requirements

¹ If the most recent set of financial statements is for a period earlier than 12 months from the date of Tender, the reason for this should be justified.

4.5 FORM FIN – 3.2:

Average Annual Construction Turnover

Tenderer's Name: _____

Date: _____

JV Member's Name _____

ITT No. and title: _____

Annual turnover data (construction only)			
Year	Amount Currency	Exchange rate	Kenya Shilling equivalent
<i>[indicate year]</i>	<i>[insert amount and indicate currency]</i>		
Average Annual Construction Turnover *			

* See Section III, Evaluation and Qualification Criteria, Sub-Factor 3.2.

4.6 FORM FIN – 3.3:

Financial Resources

Specify proposed sources of financing, such as liquid assets, unencumbered real assets, lines of credit, and other financial means, net of current commitments, available to meet the total construction cash flow demands of the subject contract or contracts as specified in Section III, Evaluation and Qualification Criteria

Financial Resources		
No.	Source of financing	Amount (Kenya Shilling equivalent)
1		
2		
3		

4.7 FORM FIN – 3.4:

Current Contract Commitments / Works in Progress

Tenderers and each member to a JV should provide information on their current commitments on all contracts that have been awarded, or for which a letter of intent or acceptance has been received, or for contracts approaching completion, but for which an unqualified, full completion certificate has yet to be issued.

Current Contract Commitments					
No.	Name of Contract	Procuring Entity's Contact Address, Tel,	Value of Outstanding Work [Current Kenya Shilling /month Equivalent]	Estimated Completion Date	Average Monthly Invoicing Over Last Six Months [Kenya Shilling /month]
1					
2					
3					
4					
5					

4.8 FORM EXP - 4.1

General Construction Experience

Tenderer's Name: _____

Date: _____

JV Member's Name _____

ITT No. and title: _____

Page _____ of _____ pages

Starting Year	Ending Year	Contract Identification	Role of Tenderer
		Contract name: _____ Brief Description of the Works performed by the Tenderer: _____ Amount of contract: _____ Name of Procuring Entity: _____ Address: _____	
		Contract name: _____ Brief Description of the Works performed by the Tenderer: _____ Amount of contract: _____ Name of Procuring Entity: _____ Address: _____	
		Contract name: _____ Brief Description of the Works performed by the Tenderer: _____ Amount of contract: _____ Name of Procuring Entity: _____ Address: _____	

4.9 FORM EXP - 4.2(a)

Specific Construction and Contract Management Experience

Tenderer's Name: _____
 Date: _____
 JV Member's Name _____
 ITT No. and title: _____

Similar Contract No.	Information			
Contract Identification				
Award date				
Completion date				
Role in Contract	Prime Contractor <input type="checkbox"/>	Member in JV <input type="checkbox"/>	Management Contractor <input type="checkbox"/>	Sub-contractor <input type="checkbox"/>
Total Contract Amount	Kenya Shilling			
If member in a JV or sub-contractor, specify participation in total Contract amount				
Procuring Entity's Name:				
Address:				
Telephone/fax number				
E-mail:				

4.10 FORM EXP - 4.2 (a) (cont.)

Specific Construction and Contract Management Experience (cont.)

Similar Contract No.	Information
Description of the similarity in accordance with Sub-Factor 4.2(a) of Section III:	
1. Amount	
2. Physical size of required works items	
3. Complexity	
4. Methods/Technology	
5. Construction rate for key activities	
6. Other Characteristics	

4.11 FORM EXP - 4.2(b)

Construction Experience in Key Activities

Tenderer's Name: _____

Date: _____

Tenderer's JV Member Name: _____

Sub-contractor's Name² (as per ITT 34): _____

ITT No. and title: _____

All Sub-contractors for key activities must complete the information in this form as per ITT 34 and Section III, Evaluation and Qualification Criteria, Sub-Factor 4.2.

1. Key Activity No One: _

Information				
Contract Identification				
Award date				
Completion date				
Role in Contract	Prime Contractor <input type="checkbox"/>	Member in JV <input type="checkbox"/>	Management Contractor <input type="checkbox"/>	Sub-contractor <input type="checkbox"/>
Total Contract Amount			Kenya Shilling	
Quantity (Volume, number or rate of production, as applicable) performed under the contract per year or part of the year	Total quantity in the contract (i)	Percentage participation (ii)		Actual Quantity Performed (i) x (ii)
Year 1				
Year 2				
Year 3				
Year 4				
Procuring Entity's Name:				
Address: Telephone/fax number E-mail:				

² If applicable

	Information
Description of the key activities in accordance with Sub-Factor 4.2(b) of Section III:	

- 2. Activity No. Two
- 3.

Fairness, Transparency & Accountability

OTHER FORMS

5. FORM OF TENDER

INSTRUCTIONS TO TENDERERS

- i) *The Tenderer must prepare this Form of Tender on stationery with its letterhead clearly showing the Tenderer's complete name and business address.*
- ii) *All italicized text is to help Tenderer in preparing this form.*
- iii) *Tenderer must complete and sign CERTIFICATE OF INDEPENDENT TENDER DETERMINATION and the SELF DECLARATION OF THE TENDERER attached to this Form of Tender.*
- iv) *The Form of Tender shall include the following Forms duly completed and signed by the Tenderer.*
 - *Tenderer's Eligibility- Confidential Business Questionnaire*
 - *Certificate of Independent Tender Determination*
 - *Self-Declaration of the Tenderer*

Date of this Tender submission: *[insert date (as day, month and year) of Tender submission]*

Request for Tender No.: *[insert identification]*

Name and description of Tender *[Insert as per ITT]*

Alternative No.: *[insert identification No if this is a Tender for an alternative]*

To: *[insert complete name of Procuring Entity]* Dear Sirs,

1. In accordance with the Conditions of Contract, Specifications, Drawings and Bills of Quantities for the execution of the above named Works, we, the undersigned offer to construct and complete the Works and remedy any defects therein for the sum of Kenya Shillings *[[Amount in figures]*_____ Kenya Shillings *[amount in words]*_____.

The above amount includes foreign currency amount (s) of *[state figure or a percentage and currency]* [figures]_____ [words]_____.

The percentage or amount quoted above does not include provisional sums, and only allows not more than two foreign currencies.

2. We undertake, if our tender is accepted, to commence the Works as soon as is reasonably possible after the receipt of the Project Manager's notice to commence, and to complete the whole of the Works comprised in the Contract within the time stated in the Special Conditions of Contract.
3. We agree to adhere by this tender until_____ *[Insert date]*, and it shall remain binding upon us and may be accepted at any time before that date.
4. Unless and until a formal Agreement is prepared and executed this tender together with your written acceptance thereof, shall constitute a binding Contract between us. We further understand that you are not bound to accept the lowest or any tender you may receive.
5. We, the undersigned, further declare that:
 - i) No reservations: We have examined and have no reservations to the tender document, including Addenda issued in accordance with ITT 28;
 - ii) Eligibility: We meet the eligibility requirements and have no conflict of interest in accordance with ITT 3 and 4;
 - iii) Tender-Securing Declaration: We have not been suspended nor declared ineligible by the Procuring Entity based on execution of a Tender-Securing or Proposal-Securing Declaration in the Procuring Entity's Country in accordance with ITT 19.8;

iv) Conformity: We offer to execute in conformity with the tendering documents and in accordance with the implementation and completion specified in the construction schedule, the following Works: *[insert a brief description of the Works]*;

v) Tender Price: The total price of our Tender, excluding any discounts offered in item 1 above is: *[Insert one of the options below as appropriate]*

vi) Option 1, in case of one lot: Total price is: *[insert the total price of the Tender in words and figures, indicating the various amounts and the respective currencies]*; Or

Option 2, in case of multiple lots:

a) Total price of each lot *[insert the total price of each lot in words and figures, indicating the various amounts and the respective currencies]*; and

b) Total price of all lots (sum of all lots) *[insert the total price of all lots in words and figures, indicating the various amounts and the respective currencies]*;

vii) Discounts: The discounts offered and the methodology for their application are:

viii) The discounts offered are: *[Specify in detail each discount offered.]*

ix) The exact method of calculations to determine the net price after application of discounts is shown below: *[Specify in detail the method that shall be used to apply the discounts]*;

x) Tender Validity Period: Our Tender shall be valid for the period specified in TDS 18.1 (as amended, if applicable) from the date fixed for the Tender submission deadline specified in TDS 22.1 (as amended, if applicable), and it shall remain binding upon us and may be accepted at any time before the expiration of that period;

xi) Performance Security: If our Tender is accepted, we commit to obtain a Performance Security in accordance with the Tendering document;

xii) One Tender Per Tender: We are not submitting any other Tender(s) as an individual Tender, and we are not participating in any other Tender(s) as a Joint Venture member or as a subcontractor, and meet the requirements of ITT 3.4, other than alternative Tenders submitted in accordance with ITT 13.3;

xiii) Suspension and Debarment: We, along with any of our subcontractors, suppliers, Project Manager, manufacturers, or service providers for any part of the contract, are not subject to, and not controlled by any entity or individual that is subject to, a temporary suspension or a debarment imposed by the Public Procurement Regulatory Authority or any other entity of the Government of Kenya, or any international organization.

xiv) State-owned enterprise or institution: *[select the appropriate option and delete the other]* *[We are not a state-owned enterprise or institution]* / *[We are a state-owned enterprise or institution but meet the requirements of ITT 3.8]*;

xv) Commissions, gratuities, fees: We have paid, or will pay the following commissions, gratuities, or fees with respect to the tender process or execution of the Contract: *[insert complete name of each Recipient, its full address, the reason for which each commission or gratuity was paid and the amount and currency of each such commission or gratuity]*.

Name of Recipient	Address	Reason	Amount

(If none has been paid or is to be paid, indicate "none.")

xvi) Binding Contract: We understand that this Tender, together with your written acceptance thereof included in your Letter of Acceptance, shall constitute a binding contract between us, until a formal contract is prepared and executed;

xvii) Not Bound to Accept: We understand that you are not bound to accept the lowest evaluated cost Tender, the Most Advantageous Tender or any other Tender that you may receive;

xviii) Fraud and Corruption: We hereby certify that we have taken steps to ensure that no person acting for us or on our behalf engages in any type of Fraud and Corruption;

Fairness, Transparency & Accountability

- xix) **Collusive practices:** We hereby certify and confirm that the tender is genuine, non-collusive and made with the intention of accepting the contract if awarded. To this effect we have signed the “Certificate of Independent Tender Determination” attached below.
- xx) We undertake to adhere by the Code of Ethics for Persons Participating in Public Procurement and Asset Disposal, copy available from _____ (*specify website*) during the procurement process and the execution of any resulting contract.
- xxi) We, the Tenderer, have completed fully and signed the following Forms as part of our Tender:
- a) Tenderer's Eligibility; Confidential Business Questionnaire – to establish we are not in any conflict to interest.
 - b) Certificate of Independent Tender Determination – to declare that we completed the tender without colluding with other tenderers.
 - c) Self-Declaration of the Tenderer – to declare that we will, if awarded a contract, not engage in any form of fraud and corruption.
 - d) Declaration and commitment to the Code of Ethics for Persons Participating in Public Procurement and Asset Disposal

Further, we confirm that we have read and understood the full content and scope of fraud and corruption as informed in “**Appendix 1- Fraud and Corruption**” attached to the Form of Tender.

Name of the Tenderer: *[insert complete name of person signing the Tender]

Name of the person duly authorized to sign the Tender on behalf of the Tenderer: **[insert complete name of person duly authorized to sign the Tender]

Title of the person signing the Tender: [insert complete title of the person signing the Tender]

Signature of the person named above: [insert signature of person whose name and capacity are shown

above] **Date signed** [insert date of signing] day of [insert month], [insert year]

Date signed _____ day of _____, _____

Notes

* In the case of the Tender submitted by joint venture specify the name of the Joint Venture as Tenderer

** Person signing the Tender shall have the power of attorney given by the Tenderer to be attached with the Tender.

A. TENDERER'S ELIGIBILITY- CONFIDENTIAL BUSINESS QUESTIONNAIRE

Instruction to Tenderer

Tender is instructed to complete the particulars required in this Form, *one form for each entity if Tender is a JV*. Tenderer is further reminded that it is an offence to give false information on this Form.

(a) Tenderer's details

	ITEM	DESCRIPTION
1	Name of the Procuring Entity	
2	Reference Number of the Tender	
3	Date and Time of Tender Opening	
4	Name of the Tenderer	
5	Full Address and Contact Details of the Tenderer.	1. Country:
		2. City
		3. Location
		4. Building
		5. Postal Address
		6. Floor
		7. Name and email of contact person.
6	Current Trade License Registration Number and Expiring date	
7	Name, country and full address (<i>postal and physical addresses, email, and telephone number</i>) of Registering Body/Agency	
8	Description of Nature of Business	
9	Maximum value of business which the Tenderer handles.	
10	State if Tenders Company is listed in stock exchange, give name and full address (<i>postal and physical addresses, email, and telephone number</i>) of state which stock exchange	

General and Specific Details

b) **Sole Proprietor**, provide the following details.

Name in full _____ Age _____ Nationality _____
 _____ Country of Origin _____ Citizenship _____

c) **Partnership**, provide the following details.

	Names of Partners	Nationality	Citizenship	% Shares owned
1				
2				
3				

d) **Registered Company**, provide the following details.

i) Private or public Company _____

ii) State the nominal and issued capital of the Company _____

Nominal Kenya Shillings (Equivalent)..... Issued

Kenya Shillings (Equivalent).....

iii) Give details of Directors as follows.

	Names of Director	Nationality	Citizenship	% Shares owned
1				
2				
3				

(e) **DISCLOSURE OF INTEREST**- Interest of the Firm in the Procuring Entity.

i) Are there any person/persons in (Name of Procuring Entity) who has/have an interest or relationship in this firm? Yes/No.....

If yes, provide details as follows.

	Names of Person	Designation in the Procuring Entity	Interest or Relationship with Tenderer
1			
2			
3			

ii) **Conflict of interest disclosure**

	Type of Conflict	Disclosure YES OR NO	If YES provide details of the relationship with Tenderer
1	Tenderer is directly or indirectly controls, is controlled by or is under common control with another tenderer.		
2	Tenderer receives or has received any direct or indirect subsidy from another tenderer.		
3	Tenderer has the same legal representative as another tenderer		
4	Tender has a relationship with another tenderer, directly or through common third parties, that puts it in a position to influence the tender of another tenderer, or influence the decisions of the Procuring Entity regarding this tendering		

	Type of Conflict	Disclosure YES OR NO	If YES provide details of the relationship with Tenderer
	process.		
5	Any of the Tenderer's affiliates participated as a consultant in the preparation of the design or technical specifications of the works that are the subject of the tender.		
6	Tenderer would be providing goods, works, non-consulting services or consulting services during implementation of the contract specified in this Tender Document.		
7	Tenderer has a close business or family relationship with a professional staff of the Procuring Entity who are directly or indirectly involved in the preparation of the Tender document or specifications of the Contract, and/or the Tender evaluation process of such contract.		
8	Tenderer has a close business or family relationship with a professional staff of the Procuring Entity who would be involved in the implementation or supervision of the such Contract.		
9	Has the conflict stemming from such relationship stated in item 7 and 8 above been resolved in a manner acceptable to the Procuring Entity throughout the tendering process and execution of the Contract.		

f) Certification

On behalf of the Tenderer, I certify that the information given above is complete, current and accurate as at the date of submission.

Full Name _____ Title or

Designation _____

(Signature)

(Date)

B. CERTIFICATE OF INDEPENDENT TENDER DETERMINATION

I, the undersigned, in submitting the accompanying Letter of Tender to the _____ [Name of Procuring Entity] for: _____ [Name and number of tender] in response to the request for tenders made by: _____ [Name of Tenderer] do hereby make the following statements that I certify to be true and complete in every respect:

I certify, on behalf of _____ [Name of Tenderer] that:

1. I have read and I understand the contents of this Certificate;
2. I understand that the Tender will be disqualified if this Certificate is found not to be true and complete in every respect;
3. I am the authorized representative of the Tenderer with authority to sign this Certificate, and to submit the Tender on behalf of the Tenderer;
4. For the purposes of this Certificate and the Tender, I understand that the word “competitor” shall include any individual or organization, other than the Tenderer, whether or not affiliated with the Tenderer, who:
 - a) has been requested to submit a Tender in response to this request for tenders;
 - b) could potentially submit a tender in response to this request for tenders, based on their qualifications, abilities or experience;
5. The Tenderer discloses that [check one of the following, as applicable]:
 - a) The Tenderer has arrived at the Tender independently from, and without consultation, communication, agreement or arrangement with, any competitor;
 - b) the Tenderer has entered into consultations, communications, agreements or arrangements with one or more competitors regarding this request for tenders, and the Tenderer discloses, in the attached document(s), complete details thereof, including the names of the competitors and the nature of, and reasons for, such consultations, communications, agreements or arrangements;
6. In particular, without limiting the generality of paragraphs (5)(a) or (5)(b) above, there has been no consultation, communication, agreement or arrangement with any competitor regarding:
 - a) prices;
 - b) methods, factors or formulas used to calculate prices;
 - c) the intention or decision to submit, or not to submit, a tender; or
 - d) the submission of a tender which does not meet the specifications of the request for Tenders; except as specifically disclosed pursuant to paragraph (5)(b) above;
7. In addition, there has been no consultation, communication, agreement or arrangement with any competitor regarding the quality, quantity, specifications or delivery particulars of the works or services to which this request for tenders relates, except as specifically authorized by the procuring authority or as specifically disclosed pursuant to paragraph (5)(b) above;
8. the terms of the Tender have not been, and will not be, knowingly disclosed by the Tenderer, directly or indirectly, to any competitor, prior to the date and time of the official tender opening, or of the awarding of the Contract, whichever comes first, unless otherwise required by law or as specifically disclosed pursuant to paragraph (5)(b) above.

Name _____ Title_ Date _____

[Name, title and signature of authorized agent of Tenderer and Date].

C. SELF - DECLARATION FORMS

FORM SD1

SELF DECLARATION THAT THE PERSON/TENDERER IS NOT DEBARRED IN THE MATTER OF THE PUBLIC PROCUREMENT AND ASSET DISPOSAL ACT 2015.

I,, of Post Office Box being a resident of in the Republic of do hereby make a statement as follows: -

1. THAT I am the Company Secretary/ Chief Executive/Managing Director/Principal Officer/Director of (*insert name of the Company*) who is a Bidder in respect of Tender No. for (*insert tender title/description*) for (*insert name of the Procuring entity*) and duly authorized and competent to make this statement.
2. THAT the aforesaid Bidder, its Directors and subcontractors have not been debarred from participating in procurement proceeding under Part IV of the Act.
3. THAT what is deponed to herein above is true to the best of my knowledge, information and belief.

..... (Title)
..... (Signature) (Date)

Bidder Official Stamp

FORM SD2

SELF DECLARATION THAT THE PERSON/TENDERER WILL NOT ENGAGE IN ANY CORRUPT OR FRAUDULENT PRACTICE

I, of P. O. Box being a resident of in the Republic of do hereby make a statement as follows: -

1. THAT I am the Chief Executive/Managing Director/Principal Officer/Director of (*insert name of the Company*) who is a Bidder in respect of Tender No. for (*insert tender title/description*) for (*insert name of the Procuring entity*) and duly authorized and competent to make this statement.
2. THAT the aforesaid Bidder, its servants and/or agents /subcontractors will not engage in any corrupt or fraudulent practice and has not been requested to pay any inducement to any member of the Board, Management, Staff and/or employees and/or agents of (*insert name of the Procuring entity*) which is the procuring entity.
3. THAT the aforesaid Bidder, its servants and/or agents /subcontractors have not offered any inducement to any member of the Board, Management, Staff and/or employees and/or agents of (name of the procuring entity)
4. THAT the aforesaid Bidder will not engage /has not engaged in any corrosive practice with other bidders participating in the subject tender
5. THAT what is deponed to herein above is true to the best of my knowledge information and belief.

.....
..... (Date) (Title) (Signature)

Bidder's Official Stamp

DECLARATION AND COMMITMENT TO THE CODE OF ETHICS

I (person) on behalf of (*Name of the Business/ Company/Firm*) declare that I have read and fully understood the contents of the Public Procurement & Asset Disposal Act, 2015, Regulations and the Code of Ethics for persons participating in Public Procurement and Asset Disposal and my responsibilities under the Code.

I do hereby commit to abide by the provisions of the Code of Ethics for persons participating in Public Procurement and Asset Disposal.

Name of Authorized signatory.....
Sign.....

Position.....
.....

Office address.....

Telephone..... E-
mail.....
...

Name of the Firm/Company.....

Date..... (Company Seal/

Rubber Stamp where applicable)

Witness

Name Sign.....

Date.....

A. APPENDIX 1- FRAUD AND CORRUPTION

(Appendix 1 shall not be modified)

1. Purpose

2. The Government of Kenya's Anti-Corruption and Economic Crime laws and their sanction's policies and procedures, Public Procurement and Asset Disposal Act (*no. 33 of 2015*) and its Regulation, and any other Kenya's Acts or Regulations related to Fraud and Corruption, and similar offences, shall apply with respect to Public Procurement Processes and Contracts that are governed by the laws of Kenya.

3. Requirements

The Government of Kenya requires that all parties including Procuring Entities, Tenderers, (applicants/proposers), Consultants, Contractors and Suppliers; any Sub- contractors, Sub-consultants, Service providers or Suppliers; any Agents (whether declared or not); and any of their Personnel, involved and engaged in procurement under Kenya's Laws and Regulation, observe the highest standard of ethics during the procurement process, selection and contract execution of all contracts, and refrain from Fraud and Corruption and fully comply with Kenya's laws and Regulations as per paragraphs 1.1 above.

Kenya's public procurement and asset disposal act (*no. 33 of 2015*) under Section 66 describes rules to be followed and actions to be taken in dealing with Corrupt, Coercive, Obstructive, Collusive or Fraudulent practices, and Conflicts of Interest in procurement including consequences for offences committed. A few of the provisions noted below highlight Kenya's policy of no tolerance for such practices and behavior: -

- 1) a person to whom this Act applies shall not be involved in any corrupt, coercive, obstructive, collusive or fraudulent practice; or conflicts of interest in any procurement or asset disposal proceeding;
- 2) A person referred to under subsection (1) who contravenes the provisions of that subsection commits an offence;
- 3) Without limiting the generality of the subsection (1) and (2), the person shall be: -
 - a) disqualified from entering into a contract for a procurement or asset disposal proceeding; or
 - b) if a contract has already been entered into with the person, the contract shall be voidable;
- 4) The voiding of a contract by the procuring entity under subsection (7) does not limit any legal remedy the procuring entity may have;
- 5) An employee or agent of the procuring entity or a member of the Board or committee of the procuring entity who has a conflict of interest with respect to a procurement: -
 - a) shall not take part in the procurement proceedings;
 - b) shall not, after a procurement contract has been entered into, take part in any decision relating to the procurement or contract; and
- c) shall not be a subcontractor for the bidder to whom was awarded contract, or a member of the group of bidders to whom the contract was awarded, but the subcontractor appointed shall meet all the requirements of this Act.
- 6) An employee, agent or member described in subsection (1) who refrains from doing

anything prohibited under that subsection, but for that subsection, would have been within his or her duties shall disclose the conflict of interest to the procuring entity;

- 7) If a person contravenes subsection (1) with respect to a conflict of interest described in subsection (5)(a) and the contract is awarded to the person or his relative or to another person in whom one of them had a direct or indirect pecuniary interest, the contract shall be terminated and all costs incurred by the public entity shall be made good by the awarding officer. Etc.

In compliance with Kenya's laws, regulations and policies mentioned above, the Procuring Entity:

- a) Defines broadly, for the purposes of the above provisions, the terms set forth below as follows:
 - i) "corrupt practice" is the offering, giving, receiving, or soliciting, directly or indirectly, of anything of value to influence improperly the actions of another party;
 - ii) "fraudulent practice" is any act or omission, including misrepresentation, that knowingly or recklessly misleads, or attempts to mislead, a party to obtain financial or other benefit or to avoid an obligation;
 - iii) "collusive practice" is an arrangement between two or more parties designed to achieve an improper purpose, including to influence improperly the actions of another party;
 - iv) "coercive practice" is impairing or harming, or threatening to impair or harm, directly or indirectly, any party or the property of the party to influence improperly the actions of a party;
 - v) "obstructive practice" is:
 - deliberately destroying, falsifying, altering, or concealing of evidence material to the investigation or making false statements to investigators in order to materially impede investigation by Public Procurement Regulatory Authority (PPRA) or any other appropriate authority appointed by Government of Kenya into allegations of a corrupt, fraudulent, coercive, or collusive practice; and/or threatening, harassing, or intimidating any party to prevent it from disclosing its knowledge of matters relevant to the investigation or from pursuing the investigation; or
 - acts intended to materially impede the exercise of the PPRA's or the appointed authority's inspection and audit rights provided for under paragraph 2.3 e. below.
- b) Defines more specifically, in accordance with the above procurement Act provisions set forth for fraudulent and collusive practices as follows:

"fraudulent practice" includes a misrepresentation of fact in order to influence a procurement or disposal process or the exercise of a contract to the detriment of the procuring entity or the tenderer or the contractor, and includes collusive practices amongst tenderers prior to or after tender submission designed to establish tender prices at artificial non-competitive levels and to deprive the procuring entity of the benefits of free and open competition.
- c) Rejects a proposal for award¹ of a contract if PPRA determines that the firm or individual recommended for award, any of its personnel, or its agents, or its sub-consultants, sub-contractors, service providers, suppliers and/ or their employees, has, directly or indirectly, engaged in corrupt, fraudulent, collusive, coercive, or obstructive practices in competing for the contract in question;
- d) Pursuant to the Kenya's above stated Acts and Regulations, may sanction or recommend to appropriate authority (ies) for sanctioning and debarment of a firm or individual, as applicable under the Acts and Regulations;

- e) Requires that a clause be included in Tender documents and Request for Proposal documents requiring (i) Tenderers (applicants/proposers), Consultants, Contractors, and Suppliers, and their Sub-contractors, Sub- consultants, Service providers, Suppliers, Agents personnel, permit the PPRA or any other appropriate authority appointed by Government of Kenya to inspect² all accounts, records and other documents relating to the procurement process, selection and/or contract execution, and to have them audited by auditors appointed by the PPRA or any other appropriate authority appointed by Government of Kenya;and
- f) Pursuant to Section 62 of the above Act, requires Applicants/Tenderers to submit along with their Applications/Tenders/Proposals a “Self-Declaration Form” as included in the procurement document declaring that they and all parties involved in the procurement process and contract execution have not engaged/will not engage in any corrupt or fraudulent practices.
-

FORM OF TENDER SECURITY-[Option 1–Demand Bank Guarantee]

Beneficiary: _____

Request **for** **Tenders** **No:**

Date: _____

TENDER GUARANTEE No.: _____

Guarantor: _____

1. We have been informed that _____ (here in after called "the Applicant") has submitted or will submit to the Beneficiary its Tender (here in after called" the Tender") for the execution of _____ under Request for Tenders No. ("the ITT").
2. Furthermore, we understand that, according to the Beneficiary's conditions, Tenders must be supported by a Tender guarantee.
3. At the request of the Applicant, we, as Guarantor, hereby irrevocably undertake to pay the Beneficiary any sum or sums not exceeding in total an amount of ____ (____) upon receipt by us of the Beneficiary's complying demand, supported by the Beneficiary's statement, whether in the demand itself or a separate signed document accompanying or identifying the demand, stating that either the Applicant:
 - (a) has withdrawn its Tender during the period of Tender validity set forth in the Applicant's Letter of Tender ("the Tender Validity Period"), or any extension thereto provided by the Applicant; or
 - b) having been notified of the acceptance of its Tender by the Beneficiary during the Tender Validity Period or any extension there to provide by the Applicant, (i) has failed to execute the contract agreement, or (ii) has failed to furnish the Performance.
4. This guarantee will expire: (a) if the Applicant is the successful Tenderer, upon our receipt of copies of the contract agreement signed by the Applicant and the Performance Security and, or (b) if the Applicant is not the successful Tenderer, upon the earlier of (i) our receipt of a copy of the Beneficiary's notification to the Applicant of the results of the Tendering process; or (ii) thirty days after the end of the Tender Validity Period.
5. Consequently, any demand for payment under this guarantee must be received by us at the office indicated above on or before that date.

[signature(s)]

FORMAT OF TENDER SECURITY [Option 2–Insurance Guarantee]

TENDER GUARANTEE No.: _____

1. Whereas [Name of the tenderer] (hereinafter called “the tenderer”) has submitted its tender dated [Date of submission of tender] for the [Name and/or description of the tender] (hereinafter called “the Tender”) for the execution of ___ under Request for Tenders No. _____ (“the ITT”).

2. KNOW ALL PEOPLE by these presents that WE of [Name of Insurance Company] having our registered office at (hereinafter called “the Guarantor”), are bound unto [Name of Procuring Entity] (hereinafter called “the Procuring Entity”) in the sum of (Currency and guarantee amount) for which payment well and truly to be made to the said Procuring Entity, the Guarantor binds itself, its successors and assigns, jointly and severally, firmly by these presents.

Sealed with the Common Seal of the said Guarantor this ___ day of _____ 20_.

3. NOW, THEREFORE, THE CONDITION OF THIS OBLIGATION is such that if the Applicant:
- a) has withdrawn its Tender during the period of Tender validity set forth in the Principal's Letter of Tender (“the Tender Validity Period”), or any extension thereto provided by the Principal; or
 - b) having been notified of the acceptance of its Tender by the Procuring Entity during the Tender Validity Period or any extension thereto provided by the Principal; (i) failed to execute the Contract agreement; or (ii) has failed to furnish the Performance Security, in accordance with the Instructions to tenderers (“ITT”) of the Procuring Entity's Tendering document.

then the guarantee undertakes to immediately pay to the Procuring Entity up to the above amount upon receipt of the Procuring Entity's first written demand, without the Procuring Entity having to substantiate its demand, provided that in its demand the Procuring Entity shall state that the demand arises from the occurrence of any of the above events, specifying which event(s) has occurred.

4. This guarantee will expire: (a) if the Applicant is the successful Tenderer, upon our receipt of copies of the contract agreement signed by the Applicant and the Performance Security and, or (b) if the Applicant is not the successful Tenderer, upon the earlier of (i) our receipt of a copy of the Beneficiary's notification to the Applicant of the results of the Tendering process; or (ii) twenty-eight days after the end of the Tender Validity Period.
5. Consequently, any demand for payment under this guarantee must be received by us at the office indicated above on or before that date.

[Date]

[Signature of the Guarantor]

[Witness]

[Seal]

TENDER-SECURING DECLARATION FORM

[The Bidder shall complete this Form in accordance with the instructions indicated]

Date:.....*[insert date (as day, month and year) of Tender Submission]*

Tender No.:.....*[insert number of tendering process]*

To:.....*[insert complete name of*

Purchaser] I/We, the undersigned, declare that:

- 1. I/We understand that, according to your conditions, bids must be supported by a Tender- Securing Declaration.
- 2. I/We accept that I/we will automatically be suspended from being eligible for tendering in any contract with the Purchaser for the period of time of *[insert number of months or years]* starting on *[insert date]*, if we are in breach of our obligation(s) under the bid conditions, because we – (a) have withdrawn our tender during the period of tender validity specified by us in the Tendering Data Sheet; or (b) having been notified of the acceptance of our Bid by the Purchaser during the period of bid validity, (i) fail or refuse to execute the Contract, if required, or (ii) fail or refuse to furnish the Performance Security, in accordance with the instructions totenders.
- 3. I/We understand that this Tender Securing Declaration shall expire if we are not the successful Tenderer(s), upon the earlier of:
 - a) our receipt of a copy of your notification of the name of the successful Tenderer; or
 - b) thirty days after the expiration of our Tender.
- 4. I/We understand that if I am/we are/in a Joint Venture, the Tender Securing Declaration must be in the name of the Joint Venture that submits the bid, and the Joint Venture has not been legally constituted at the time of bidding, the Tender Securing Declaration shall be in the names of all future partners as named in the letter of intent.

Signed:.....

Capacity / title (director or partner or sole proprietor, etc.).....Name:

..... Duly

authorized to sign the bid for and on behalf of: *[insert complete name of Tenderer]*

Dated on day of *[Insert date of signing]*

Seal or stamp

Appendix to Tender

Schedule of Currency requirements

Summary of currencies of the Tender for **CONSTRUCTION OF BEKIBON WATER SUPPLY PROJECT WATER PROJECT**

<i>Name of currency</i>	<i>Amounts payable</i>
Local currency: _____	
Foreign currency #1: _____	
Foreign currency #2: _____	
Foreign currency #3: _____	
Provisional sums expressed in local currency	[To be entered by the Procuring Entity]

Fairness, Transparency & Accountability

PART II - WORK REQUIREMENTS

SECTION V - DRAWINGS

A list of drawings should be inserted here. The actual drawings including Site plans should be annexed in a separate booklet.

SECTION VI - SPECIFICATIONS

A. GENERAL

All materials, equipment and testing apparatus etc. to be furnished and Works to be executed by the Contractor in this Contract shall conform to the requirements of the latest Kenya Standards, International Standards Organization (ISO) Standards, DIN, British Standards or other approved applicable Standard in Kenya, unless otherwise specifically stated.

Equipment to be purchased shall be from well recognized manufacturers whose products are standardized and controlled by any recognised Standards Organisation.

All dimensions and measurement units shall be in S.I. units.

The Contractor may propose to the Engineer an alternative Standard other than specified, in which case he shall submit six (6) copies of the English translation of the proposed Standard and all other information for the materials, equipment and testing, together with written proof from a recognized Standards Organisation that the proposed Standard is equivalent in all significant respects to the Standard specified.

The equipment to be employed by the Contractor shall have sufficient performance capacity and durability as to secure the completion of the Works within the construction period stipulated under the Contract. All materials and equipment shall be subject to inspections or tests by the Engineer at any time and in any state of completion both off-site and on-site as he deems necessary. **The Contractor shall furnish promptly, without additional charge, all facilities, labour and materials reasonably needed for performing such inspections and tests as may be required by the Engineer.**

The Contractor shall make diligent efforts to procure the specified materials, but when the materials specified are unavailable, for reasons beyond the control of the Contractor, substitutes may be used with prior written approval of the Engineer.

B. OFFICE FOR CONTRACTOR

The Contractor shall have an office on the site to be approved by the Engineer and which shall be open and attended to at all hours during which work is in progress.

Notwithstanding anything contained in Clause 6.1 of the General Conditions of Contract, any notice to be given to or served upon the Contractor shall be deemed and taken to be efficiently given or served by the delivery thereof at such office on the site.

C. PROTECTION OF WORKS

The Contractor shall carefully protect from injury by weather all work and materials which may be affected thereby.

D. DAMAGE TO LAND

Except where specified for the proper execution of the Works, the Contractor shall not interfere with any fence, hedge, tree, land or crops within, upon or forming the boundary of the site or elsewhere. In the event of such interference, the Contractor shall make good to the satisfaction of the owner and the Engineer and shall pay to the owner such damages as the Engineer may determine.

E. RIVERS AND DRAINS

The Contractor shall at all times maintain the free flow of rivers and drains and prevent excavated material from the Works from being deposited in them.

F. SERVICES

Before commencing Works which include excavation or ground levelling by manual or mechanical excavation the Contractor shall at his own expenses ascertain in writing from Telkom Kenya, Kenya Power & Lighting Co. Ltd. and all other Public Bodies, Companies and persons who may be affected, the position and depth of their respective ducts, cables, mains, pipes, or other appurtenances. He shall thereupon search for and locate such services.

The Contractor shall at his own expense arrange to have effectually propped, protected, underpinned, altered, diverted, restored and made as may be necessary, all water courses, pipes, cables or ducts, poles or wires or their appurtenances disturbed or damaged during the progress of the Works, or in consequence thereof.

Except that such services as require to be removed or altered by virtue of the layout of the permanent work and not the manner in which the work is carried out, shall be so removed or altered at the direction and at the expense of the Employer.

The Contractor shall be liable for the cost of repairs to any services damaged as a result of carrying out the Works and execution of these Works.

G. PRIVATELY OWNED OR PUBLIC SERVICES

If any privately owned or public services passing through the site will be affected by the Works, the Contractor shall provide at his own expense a satisfactory alternative service in full working order to the satisfaction of the owner of the services and the Engineer, before the cutting of the existing service. Any damage to private or public services shall be made good by the Contractor at his cost.

In case the remedial work is not executed promptly by the Contractor, the Engineer may make alternative arrangements for the execution of the work and debit the costs to the Contractor.

H. WATER SUPPLY

The Contractor shall provide for all purposes of the work, an adequate supply of water from a suitable source or sources approved by the Engineer. He must pay the water charges, if any, and make arrangements for supply, transport and distribution.

I. ADDITIONAL LAND

The Contractor shall select and arrange at his own expenses for any temporary occupation of land outside the site which he requires for the efficient execution of the Works. The Contractor must comply fully with all By-laws and Regulations currently in force in the area.

J. USE OF HEAVY PLANT

In the event of the Contractor desiring to use heavy machinery or plant, he shall first satisfy the Engineer that they will be of such size and used in such a manner as not to cause any disturbance or damage in particular to water, electricity, Post Office or other mains, cables and connections or to sewers, culverts etc. or interfere with the line or position of any overhead wires and cables of any sort, telegraph poles,

power poles etc.

The Contractor will be held liable for any such damage or disturbance and shall pay the full costs of any reinstatement, relaying, repairing or refixing as may be required, as agreed between the Engineer and the owner affected.

K. PROVISION OF INSTRUMENTS AND LABOUR

The Contractor shall provide at his own expenses all instruments, materials, tools and other things which the Project Manager considers necessary for his proper supervision of the Works and shall maintain the same in good order. He shall also provide materials, an experienced Surveyor and labour for attendance on the Engineer and his representatives in carrying out operations connected with the supervision of the Works. All charges arising out of such services shall be deemed to be included in his rates in the Bill of Quantities.

L. ACCESS TO SITES

The Contractor shall construct and maintain all temporary accesses required for the execution of the Works. Access roads shall be constructed and maintained up to the site office and Resident / Assistant Resident Engineer's houses. The cost of all these Works shall be deemed to be covered by rates and prices quoted by the Contractor.

M. POLLUTION

The Contractor shall ensure that during the course of his operations no pollution of the atmosphere, rivers, reservoir catchment areas or groundwater is allowed to take place.

N. TREE PROTECTION

Trees within the permanent and temporary easement are the property of owners. Specific trees will be identified by the Engineer, prior to construction, and the Contractor shall neither remove nor cut their roots unless otherwise directed by the Engineer. If the roots of such trees appear within the trench areas, the Contractor shall handle the roots with maximum care so that no portion of the roots will be damaged. During the excavation of the trench, the exposed roots may be removed to a position that will not damage the roots and will not interfere with the pipelaying. During the construction, the roots shall be thoroughly protected by appropriate cover and wetted as directed. After the pipes are laid, the moved roots shall be placed back to the original locations and backfilled carefully by selected soft soil which can support vegetation.

O. WATCHING, FENCING AND LIGHTING

The Contractor shall arrange to employ watchmen to guard the Works both during the day and night from the commencement of the Works until the substantial completion of the Works.

Any excavation or other obstruction likely to cause injury or damage to any person or domestic animals must be fenced off as directed by the Engineer.

P. TIPS

The Contractor shall be responsible for provision of all tips, at his own expense, for disposal of all spoil or other rubbish collected during the construction of the Works. Any surplus excavated material not required shall also be carted away to these tips. The site of the tips must be approved by the Engineer.

Q. TROPICALISATION

In choosing materials and their finishes, due regard shall be given to the tropical conditions of the site to which they will be subjected. The Contractor shall submit details of his practices which have proven

satisfactory and which he recommends for application on the parts of the Works which may be affected by the tropical conditions.

R. PROGRESS MEETINGS

Throughout the project period, progress meetings will be held to discuss the progress of the work, schedule for the ensuing month, methods of construction, procurement, transportation, labours, etc. These meetings can be called at any time intervals at the request of the Contractor or as directed by the Project Manager.

S. INSPECTION BY ENGINEER DURING DEFECTS LIABILITY PERIOD

The Engineer will give the Contractor due notice of his intention to carry out inspection during the Defects Liability Period and the Contractor shall upon receipt of such notice arrange for a responsible representative to be present at the times and dates named by the Engineer. This representative shall render all necessary assistance and take notice of all matters and things to which his attention is directed by the Engineer.

T. SUBMISSION OF SAMPLES

Before incorporating in the finished work any materials or articles which he supplies under the terms of the Contract, the Contractor shall submit to the Engineer's Representative for his approval a sample of each respective material or article, and such samples shall be delivered to and kept at his office for reference. All the respective kinds of materials and articles used in and upon the Works, shall be at least equal in quality to the approved samples. Each and every sample shall be a fair average of the bulk material or of the article which it represents. The Engineer's Representative may decide the method by which each sample to be taken from the bulk material shall be obtained.

U. RESPONSIBILITY FOR ORDERING MATERIALS AND MANUFACTURED ARTICLES AND SAMPLES FOR TESTING

The responsibility for so ordering and delivering materials and manufactured articles and samples that they may be tested sufficiently far in advance of the work as not to delay it, shall rest upon the Contractor, and he shall not be entitled to any time credit for delay occasioned by his neglect to order sufficiently well in advance or to effect payment of any costs he may incur as a result thereof.

With regard to any item in the Bill of Quantities which is the subject of a P.C. Sum, the Contractor shall notify the Engineer of his requirements as early as possible leaving ample time for the Engineer to make any necessary arrangements so that no delay occurs in the progress of the work.

V. TESTS OF MATERIALS AND MANUFACTURED ARTICLES BEFORE USE

Any or all of the materials and manufactured articles supplied by the Contractor for use on any of the Works throughout this Contract shall be subject in advance to tests as may be specified in the relevant Standard Specification as may from time to time be deemed necessary by the Engineer. Samples of all such materials and manufactured articles, together with all the necessary labour, materials, plant and apparatus for sampling and for carrying out of tests on the site on all such materials and manufactured articles shall be supplied by the Contractor at his own expenses. The cost of special tests ordered by the Engineer to be carried out by an independent person at a place other than the site or place of manufacture or fabrication shall be borne by the Contractor.

W. REJECTED MATERIALS

Should any material or manufactured articles be brought on to the site of the Works which are in the judgement of the Engineer unsound or of inferior quality or in any way unsuited for the work in which it is proposed to employ them, such materials or manufactured articles shall not be used upon the Works but shall be branded if, in the opinion of the Engineer, this is necessary and shall forthwith be

removed from the site of the Works, all at the Contractor's expense and in each case as the Engineer shall direct.

X. QUALITY OF MATERIALS AND WORKMANSHIP

The materials and workmanship shall be of the best of their respective kinds and shall be to the approval of the Engineer. In the reading of this Specification the words "to the approval of the Engineer" shall be deemed to be included in the description of all materials incorporated in the Works, whether manufactured or natural and in the description of all operations for the due execution of the Works.

Y. CONSTRUCTION PROGRAMME

The Contractor shall submit to the Engineer for approval, a revision of the Construction Programme attached in four (4) copies and after approval to the Employer in two (2) copies in the following manner:

- (1) Within seven (7) days after receiving the Letter of Acceptance, the Contractor shall submit to the Engineer for approval, a detailed Programme based on the key date stated hereinafter or other dates which are given in the Letter of Acceptance in the form of a Critical Path Method (hereinafter referred to as CPM Network) showing the order of procedure in which he proposes to carry out the Works including design, manufacture, delivery to the site, transport, storage, survey, construction, commissioning and maintenance. This Programme shall indicate clearly all activities and its duration along with the earliest and the latest event, times and the first and last dates of the submission of the Drawings and each date of shop inspection by the Engineer for the section or portion of the Works.

The Programme so prepared shall be rearranged in the form of a Time Bar-chart Schedule of which size shall be 841mm x 594mm (A-1 size). This Time Bar-chart Schedule shall be submitted to the Engineer together with the CPM Network.

- (2) The CPM Network shall be in accordance with commonly accepted practices and shall show graphically the chain of activities / sub-activities and their sequential relationship with each other from the start of construction to the completion of the Contract. The Time Bar-chart Schedule shown in weeks shall list all main activities and its applicable sub-activities.
- (3) In preparing the CPM Network and the Time Bar-chart Schedule the Contractor shall make due allowances for possible delays. Under no circumstances shall the CPM Network or the Time Bar-chart Schedule show a completion in excess of the "Time for Completion" stated in the Form of Tender.
- (4) The Programme once approved by the Engineer shall thereafter be referred to as the Contractual Programme. The Engineer's approval of such Programme shall not relieve the Contractor of any of his duties or responsibilities under the Contract.

2.1 CLEARING SITE

The Contractor shall demolish, break up and remove buildings, walls, gates, fences, advertisements and other structures and obstructions, grub up and remove trees, hedges, bushes and shrubs and clear the site of the works at such time and to the extent required by the Engineer but not otherwise, subject to the provisions of Clause 27 of the Conditions of Contract: the materials so obtained shall so far as suitable be reserved and stacked for further use; all rubbish and materials for use shall be destroyed or removed from the site, as directed by the Engineer.

Where top soil has to be excavated this shall be removed and stacked on site. After completion of construction, it shall be spread over the disturbed ground, any surplus being disposed of as directed by the Engineer.

Underground structures and chambers where required to be demolished, shall be demolished to depths shown on drawings or as directed. They shall be properly cleaned out and backfilled and compacted with suitable material to the direction and approval of the Engineer.

2.2 VEGETATION

No allowance will be made for the cutting and removal of crops, grass, weeds and similar vegetation. The cost of all such work will be held to be included in the rates entered in the Bill of Quantities.

2.3 BUSHES AND SMALL TREES

All bushes and small trees, the main stem of which is less than 500mm girth at 1 metre above ground level shall be uprooted (unless otherwise directed by the Engineer) and burnt or otherwise disposed off as directed by the Engineer.

2.4 GRUBBING-UP ROOTS

Stumps and tree roots shall, unless otherwise directed, be grubbed up, blasted, burnt or removed and disposed of in approved dumps to be provided by the Contractor. Where directed by the Engineer, the holes resulting from grubbing up shall be filled with approved materials, which shall be deposited and compacted in layers not exceeding 225mm loose depth, to the same dry density as that of the adjoining soil. For the purpose of measurement, tree roots shall be classified according to the mean diameter of the stump measured across the cut.

2. EXCAVATION

DEFINITION AND CLASSIFICATION OF EXCAVATED MATERIALS

Excavation in the Bills of Quantities shall be excavation in any material which in the opinion of the Engineer can be excavated by use of pick axes and hand levers. Water logged material shall be included in this class. Murram in any form shall also be included.

COMPACTION OF FILL

All materials used in fill shall be compacted to specification by plant approved by the Engineer for that purpose. Maximum compacted thickness of such layers shall not be more than 200mm.

Work on the compaction of plastic materials for fill shall proceed as soon as practicable after excavation and shall be carried out only when the moisture content is not greater than 2 per cent above the plastic limit for that material. Where the moisture content of plastic material as excavated is higher than this value the material shall be run to spoil and an equal volume of material suitable for filling shall be replaced, unless the Contractor prefers, at his own expense, to wait until the material has dried sufficiently for acceptance again as suitable material.

STONE REVETMENTS (STONE PITCHING)

Where shown on the drawings, the slopes of embankments, rivers, streams, watercourses and other surfaces shall be protected against water or other action by hand-set stone facing set on end. The larger stones shall be roughly dressed on the bed and face, and roughly square to the full depth of the joints. No rounded boulder shall be used, or stones less than 225mm in depth of 0.05 cubic metre in volume. The stones shall be laid to break bond, and shall be well bedded on to a 75mm layer of gravel or fine rubble rammed to a uniform surface and the whole work finished to the satisfaction of the

Engineer. Where required, a trench shall be excavated at the bottom of the slope to such a depth as will ensure a safe foundation for the revetment.

TRENCHES OF GREATER WIDTH AND DEPTH THAN NECESSARY

The Contractor shall not be entitled to payment in respect of excavation to any greater extent, whether horizontally or vertically, than is necessary to receive any structure for which the excavation is intended, except where a separate item is provided for additional excavation for working space, timbering, or other temporary work. Excavation to a greater depth or width than directed shall be made good with suitable materials to the satisfaction of the Engineer and at the Contractor's cost.

SUPPORTS FOR TRENCHES

The sides of trenches shall where necessary be adequately supported to the satisfaction of the Engineer by timber or other approved means.

PROVISION OF SPOIL HEAPS

The Contractor shall provide spoil heaps at his own expense for the disposal of surplus material and all rubbish collected when clearing the site and during the construction of the works. The sites for these shall be approved by the Engineer.

WATER IN EXCAVATIONS

All excavations shall be kept free from water, from whatever source, at all times during construction of works until in the opinion of the Engineer, any concrete or other works therein are sufficiently set. The Contractor's rates are deemed to cover compliance with this requirement.

The Contractor shall construct any sumps or temporary drains that the Engineer may deem necessary and shall be responsible for the removal and disposal of all water entering the excavations from whatever source and shall deal with and dispose of such water in a manner approved by the Engineer so as to ensure that excavations are kept dry.

The Contractor shall provide all plant, labour and materials required for such work and all costs incurred shall be deemed to be included in his rates for excavation.

A. CONCRETE

DEFINITIONS

Structural concrete is any class of concrete which is used in reinforced, prestressed or unreinforced concrete construction, which is subject to stress.

Non-structural concrete is composed of materials complying with the Specification but for which no strength requirements are specified and which is used only for filling voids, blinding foundations and similar purposes where it is not subjected to significant stress.

A formed surface is a face which has been cast against formwork.

An unformed surface is a horizontal or nearly horizontal surface produced by screeding or trowelling to the level and finish required.

A pour refers to the operation of placing concrete into any mould, bay or formwork, etc. and also to the volume which has to be filled. Pours in vertical succession are referred to as lifts. **THE DESIGN OF CONCRETE MIXES**

The classes of structural concrete to be used in the works shall be those shown on the Drawings and designated in Table 4.1, in which the class designation includes two figures. The first figure is the nominal strength at 28 days expressed in N/mm² and the second figure is the maximum nominal size of aggregate in the mix expressed in millimetres.

Table 4.1 - CONCRETE CLASSES AND STRENGTHS

Class of Concrete	Nominal Strength N/mm ²	Maximum Nominal Size of Aggregate mm	Maximum Water / Cement Ratio		Trial Mixes Target Mean Strength (Clause 401 c) N/mm ²	Early Works Test Cubes (Clause 401 d)	
			A	B		Any one Cube N/mm ²	Average of any Group of 4 Cubes N/mm ²
10/75	10	75	0.60	0.55	13.5	8.5	13.3
15/75	15	75	0.60	0.50	21.5	12.8	20.0
15/40	15	40	0.60	0.50	21.5	12.8	20.0
15/20	15	20	0.57	0.50	21.5	12.8	20.0
20/40	20	40	0.55	0.48	31.5	17.0	27.5
20/20	20	20	0.53	0.48	31.5	17.0	27.5
20/10	20	10	0.50	0.48	31.5	17.0	27.5
25/40	25	40	0.52	0.46	36.5	21.3	32.5
25/20	25	20	0.50	0.46	36.5	21.3	32.5
25/10	25	10	0.48	0.46	36.5	21.3	32.5
30/40	30	40	0.50	0.45	41.5	25.5	37.5
30/20	30	20	0.48	0.45	41.5	25.5	37.5
30/10	30	10	0.47	0.45	41.5	25.5	37.5
40/20	40	20	0.46	0.43	51.5	34.0	47.5
40/10	40	10	0.45	0.43	51.5	34.0	47.5

HAND-MIXED CONCRETE

Concrete for structural purposes shall not be mixed by hand. Where non-structural concrete is required, hand mixing may be carried out subject to the agreement of the Engineer.

The mixing shall be done on a hard impermeable surface. The materials shall be turned over not less than three times dry, water shall then be sprayed on and the materials again turned over not less than three times in a wet condition and worked together until a mixture of uniform consistency is obtained.

For hand mixed concrete the specified quantities of cement shall be increased by 10% and not more than 0.5 cubic metre shall be mixed at one time. During windy weather efficient precautions shall be taken to prevent cement from being blown away during the process of gauging and mixing.

TRANSPORT OF CONCRETE

The concrete shall be transported to the Works by means which shall prevent adulteration, segregation or loss of ingredients, and which shall ensure that the concrete is of the required workability and consistency at the point and time of placing.

The time elapsed between mixing and placing a batch of concrete shall be as short as practicable and in any case not longer than will permit completion of placing and compaction before the onset of initial set. If the placing of any batch of concrete is delayed beyond this period, the concrete shall not be placed in the Works.

PLACING OF CONCRETE

a) Consent for placing

Concrete shall not be placed in any part of the Works until the Engineer's consent has been given in writing, and the Contractor shall give the Engineer at least 1 full working day's notice of his intention to place concrete.

If concrete placing is not commenced within 24 hours of the Engineer's consent the Contractor shall again request consent as specified above.

b) Preparation of surface to receive concrete

Excavated surfaces on which concrete is to be deposited shall be prepared as set out in Section 3 of this Specification.

Existing concrete surfaces shall be prepared as set out in Clause 414. Before deposition of further concrete, they shall be clean, hard and sound and shall be wet but without any free- standing water.

Any flow of water into an excavation shall be diverted through proper side drains to a sump, or be removed by other suitable methods which will prevent washing away the freshly deposited concrete or any of its constituents. Any underdrains constructed for this purpose shall be completely grouted up when they are no longer required by a method agreed by the Engineer.

Unless otherwise instructed by the Engineer surfaces against which concrete is to be placed shall receive a prior coating of mortar mixed in the proportions similar to those of the fines portion in the concrete to be placed. The mortar shall be kept ahead of the concrete. The mortar shall be well worked into all parts of the excavated surface and shall not be less than 5mm thick.

If any fissures have been cleaned out as described in Section 3 of this Specification they shall be filled with mortar or with concrete as instructed by the Engineer.

The amount of mortar placed at any one time shall be limited so that it does not dry out or set before being covered with concrete.

c) Chutes

In general, transportation of concrete by the use of chutes will not be permitted unless approved by the Engineer. The chute shall have a section with round corners and shall have a proper fixed slope so as to allow the concrete to flow satisfactorily and without segregation. The lower end of chute shall be provided with a drop chute not less than 0.6m in height to avoid segregation of falling concrete. The height of drop shall not exceed 1.5m. Chutes shall be protected from direct sunlight, wind and rain.

e) Placing procedures

The concrete shall be deposited as nearly as possible in its final position. It shall be placed so as to avoid segregation of the concrete and displacement of the reinforcement, other embedded items, or formwork. It shall be brought up in layers approximately parallel to the construction joint planes and not exceeding 500mm in compacted thickness unless otherwise permitted or directed by the Engineer, but the layers shall not be thinner than four times the maximum nominal size of aggregate.

Layers shall be placed so that they do not form feather edges nor shall they be placed on a previous layer which has taken its initial set. In order to comply with this requirement, a layer may be started before completion of the preceding layer.

All the concrete in a single bay or pour shall be placed in a continuous operation. It shall be carefully worked round all obstructions, irregularities in the foundations and the like so that all parts are completely full of compacted concrete with no segregation or honeycombing. It shall also be carefully worked round and between waterstops, reinforcement, embedded steelwork and similar items which protrude above the surface of the completed pour.

All work shall be completed on each batch of concrete before its initial set commences and thereafter the concrete shall not be disturbed before it has set hard. No concrete that has partially hardened during transit shall be used in the Works and the transport of concrete from the mixer to the point of placing shall be such that this requirement can be complied with.

Concrete shall not be placed during rain which is sufficiently heavy or prolonged as to wash mortar from coarse aggregate on the exposed faces of fresh concrete. Means shall be provided to remove any water accumulating on the surface of the placed concrete. Concrete shall not be deposited into such accumulation of water.

In drying weather, covers shall be provided for all fresh concrete surfaces which are not being worked on. Water shall not be added to concrete for any reason. When concrete is discharged above its place of final deposition, segregation shall be prevented by the use of chutes, downpipes, trunking, baffles or other appropriate devices, as approved by the Engineer.

f) Interruptions to placing

If concrete placing is interrupted for any reason and the duration of the interruption cannot be forecast or is likely to be prolonged, the Contractor shall immediately take the necessary action to form a construction joint so as to eliminate as far as possible feather edges and sloping top surfaces and shall thoroughly compact the concrete already placed in accordance with Clause 406. All work on the concrete shall be completed while it is still plastic and it shall not thereafter be disturbed until it is hard enough to resist damage. Plant and materials to comply with this requirement shall be readily available at all times during concrete placing.

Before concreting is resumed after such an interruption the Contractor shall cut out and remove all damaged or uncompacted concrete, feather edges or any other undesirable features and shall leave a clean sound surface against which the fresh concrete may be placed.

If it becomes possible to resume concrete placing without contravening the Specification and the Engineer consents to a resumption, the new concrete shall be thoroughly worked in and compacted against the existing concrete so as to eliminate any cold joints.

g) Dimensions of pours

Unless otherwise agreed by the Engineer, pours shall not be more than two metres high and shall as far as possible have a uniform thickness over the plan area of the pour. Concrete shall be placed to the full planned height of all pours except in the circumstances described in sub-clause 405(d).

The Contractor shall plan the dimensions and sequence of pours in such a way that cracking of the concrete does not take place due to thermal or shrinkage stresses.

h) Placing sequence

The Contractor shall arrange that as far as possible the intervals between placing successive lifts of concrete in one section of the Works are of equal duration. This duration shall normally be not less than three or more than seven days under temperate weather conditions unless otherwise agreed by the Engineer.

Where required by the Engineer to limit the opening of construction joints due to shrinkage, concrete shall not be placed against adjacent concrete which is less than 21 days old.

When the drawings call for contraction gaps in concrete, these shall be of the widths and in the locations shown on the drawings and they shall not be filled until the full time interval shown on the drawings has elapsed.

COMPACTION OF CONCRETE

The concrete shall be fully compacted throughout the full extent of the placed layer. It shall be thoroughly worked against the formwork and around any reinforcement and other embedded items, without displacing them. Particular care shall be taken at arises and other confined spaces. Successive layers of the same pour shall be thoroughly worked together.

Concrete shall be compacted with the assistance of mechanical immersion vibrators, unless the Engineer agrees to another method.

Immersion vibrators shall operate at a frequency of between 7,000 and 10,000 cycles per minute. The Contractor shall ensure that vibrators are operated at pressures and voltages not less than those recommended by the manufacturer in order that the compactive effort is not reduced.

A sufficient number of vibrators shall be operated to enable the entire quantity of concrete being placed to be vibrated for the necessary period and, in addition, standby vibrators shall be available for instant use at each place where concrete is being placed.

Where the concrete contains aggregate with a nominal size of 75mm or more, vibrators with a diameter of 100mm or more shall be used.

Vibration shall be continued at each point until the concrete ceases to contract, a thin layer of mortar has appeared on the surface and air bubbles have ceased to appear. Vibrators shall not be used to move concrete laterally and shall be withdrawn slowly to prevent the formation of voids.

Vibration shall not be applied by way of reinforcement nor shall vibrators be allowed to touch reinforcement or other embedded items. The vibrators shall be inserted vertically into the concrete to penetrate the layer underneath at regular spacing. The spacing shall not exceed the distance from the vibrator over which vibration is visibly effective.

CURING OF CONCRETE

a) General

Concrete shall be protected during the first stage of hardening from loss of moisture and from the development of temperature differentials within the concrete sufficient to cause cracking. The methods used for curing shall not cause damage of any kind to the concrete.

Curing shall be continued for as long as may be necessary to achieve the above objectives but in any case for at least seven days or until the concrete is covered by later construction whichever is the shorter period.

The above objectives are dealt with in sub-clause 407(b) and (c) but nothing shall prevent both objectives being achieved by a single method where circumstances permit.

The curing process shall commence as soon as the concrete is hard enough to resist damage from the process, and in the case of large areas or continuous pours, shall commence on the completed section of the pour before the rest of the pour is finished.

Details of the Contractor's proposals for curing concrete shall be submitted to the Engineer before the placing of concrete commences in the Works.

Formed surfaces may be cured by retaining the formwork in place for the required curing period.

If the use of the foregoing methods is inappropriate, surfaces which will not have further concrete bonded to them and which are not to receive an application of a finish may be cured by the application of a curing compound having an efficiency index of at least 90 percent. Curing compounds shall contain a fugitive dye to enable the extent of the spread to be seen easily.

Curing compound is used on surfaces exposed to the atmosphere shall contain sufficient finely divided flake aluminium in suspension to produce a complete coverage of the surface with a metallic finish when applied at the rate recommended by the manufacturer.

Curing compounds shall become stable and impervious to the evaporation of water from the concrete surface within 60 minutes of application. The material shall not react chemically with the concrete surfaces for at least the first four days of the curing period.

If instructed by the Engineer, the Contractor shall, in addition to the curing provisions set out above provide a suitable form of shading to prevent the direct rays of the sun reaching the concrete surfaces for at least the first four days of the curing period.

b) Loss of moisture

Exposed concrete surfaces shall be closely covered with impermeable sheeting, properly secured to prevent its removal by wind and the development of air spaces beneath it. Joints in the sheeting shall be lapped by at least 300mm.

If for some reason it is not possible to use impermeable sheeting, the Contractor shall keep the exposed surfaces continuously wet by means of a water spray or by covering with a water absorbent material which is kept wet, unless this method conflicts with sub-clause 407(c).

Water used for curing shall be of the same quality as that used for concrete mixing as stated in sub-clause 702(g).

c) Limitation of temperature differential

The Contractor shall limit the development of temperature differentials in concrete after placing by any means appropriate to the circumstances including the following:

i) Limiting concrete temperatures at placing as set out in sub-clause 409(b);

- ii) Use of low heat cement, subject to the agreement of the Engineer;
- iii) Insulation of exposed concrete surface by insulating blankets. Such blankets shall have an insulation value at least equivalent to 50mm of dry mineral wool;
- iv) Leaving formwork in place during the curing period. Steel forms shall be suitably insulated on the outside;
- v) Preventing rapid dissipation of heat from surfaces by shielding from wind; Avoiding the use of water sprays when such use would cause rapid cooling of the surface.

PROTECTION OF FRESH CONCRETE

Freshly placed concrete shall be protected from rainfall and from water running over the surface until it is sufficiently hard to resist damage from these causes.

No traffic shall be allowed on any concrete surface until such time as it is hard enough to resist damage by such traffic.

Concrete placed in the Works shall not be subjected to any loading until it has attained at least its nominal strength as defined in Clause 401.

If the Contractor desires to impose loads on newly-placed concrete, he shall make at least three test cubes and cure them in the same conditions as the concrete they represent. These cubes shall be tested singly at suitable intervals in order to estimate the time at which the nominal strength is reached.

CONCRETING IN HOT WEATHER

a) General

The Contractor shall prevent damage to concrete arising from exposure to extreme temperatures, and shall maintain in good working order all plant and equipment required for this purpose.

In the event that conditions become such that even with the use of the equipment the requirements cannot be met, concrete placing shall immediately cease until such time as the requirements can again be met.

b) Concrete placing in hot weather

During hot weather the Contractor shall take all measures necessary to ensure that the temperature of concrete at the time of placing in the Works does not exceed 30 degrees centigrade and that the concrete does not lose any moisture during transporting and placing.

Such measures may include but are not necessarily limited to the following:-

- i) Shielding aggregates from direct sunshine.
- ii) Use of a mist water spray on aggregates
- iii) Sun shields on mixing plants and transporting equipment.
- iv) Cooling the mixing water. If ice is used for this purpose it should preferably be in flake form. Lump ice shall not be allowed to enter the tank supplying the mixer drum.
- v) Covering skips closely with polythene sheet so that the latter is in contact with the concrete.

Areas in which concrete is to be placed shall be shielded from direct sunshine and rock or concrete

surfaces shall be thoroughly wetted to reduce absorption of water from the concrete placed on or against them. After concrete in any part of an area has been placed, the selected curing process shall be commenced as soon as possible. If any interval occurs between completion of placing and start of curing, the concrete shall be closely covered during the interval with polythene sheet to prevent loss of moisture.

FINISHES ON UNFORMED SURFACES

Horizontal or nearly horizontal surfaces which are not cast against formwork shall be finished to the class shown on the drawings and defined hereunder.

UF 1 Finish

All surfaces on which no higher class of finish is called for on the drawings or instructed by the Engineer shall be given a UF 1 finish.

The concrete shall be levelled and screeded to produce a uniform plain or ridged surface, surplus concrete being struck off by a straight edge immediately after compaction.

UF 2 Finish

This is a floated finish for roof or floor slabs and other surfaces where a hard trowelled surface is not required.

The surface shall first be treated as a Class UF 1 finish and after the concrete has hardened sufficiently, it shall be floated by hand or machine sufficiently only to produce a uniform surface free from screed marks.

UF 3 Finish

This is a hard trowelled surface for use where weather resistance or appearance is important, or which is subject to high velocity water flow.

The surface shall be floated as for a UF 2 finish but to the tolerance stated below. When the moisture film has disappeared and the concrete has hardened sufficiently to prevent laitance from being worked to the surface, it shall be steel trowelled under firm pressure to produce a dense, smooth uniform surface free from trowel marks.

Table 4.4 - SURFACE TOLERANCES

Class of Finish	Tolerance in mm. See notes		
	A	B	C
UF 1	N/A	10	+ 20 or - 10
UF 2	Nil	10	+ 20 or - 10
UF 3	Nil	5	+ 12.5 or -7.5

Notes:

- Col. A is the maximum allowable value of any sudden change of level in the surface.
- Col. B is the maximum allowable value of any gradual irregularity of the surface, as indicated by the gap between the surface and a three metre long straight edge or correctly shaped template placed on the surface.
- Col. C is the maximum allowable value of the difference in level or position between a three metre long straight edge or correctly shaped template placed on the surface and the specified level or position of that surface.

Where dimensional tolerances are given on the drawings or in this Special Specification they shall take precedence over those given in Table 4.4.

AA. MORTAR

This clause covers mortar for use ahead of concrete placing, and other uses not covered elsewhere in the Specification.

Mortar shall be composed of fine aggregate complying with sub-clause 702(c) and ordinary Portland cement complying with SRN 103. The mix proportions shall be as stated on the drawings or elsewhere in this Specification or if not stated shall be one part of cement to two parts of fine aggregate by weight.

Small quantities of mortar may be hand mixed but for amounts over 0.5 cubic metre a mechanical mixer shall be used.

The water content of the mortar shall be as low as possible consistent with the use for which it is required but in any case the water/cement ratio shall not be more than 0.5.

Mortar which is specified as 'dry pack' shall be mixed with sufficient water for the mix to become cohesive but not plastic when squeezed in the hand. Dry pack mortar shall be rammed into the cavity it is required to fill, using a hand rammer with sufficient force to ensure full compaction.

REMEDIAL WORK TO DEFECTIVE SURFACES

If on stripping any formwork the concrete surface is found to be defective in any way, the Contractor shall make no attempt to remedy such defects prior to the Engineer's inspection and the receipt of any instructions which the Engineer may give.

Defective surfaces shall not be made good by plastering.

Areas of honey combing (of a mild nature) which the Engineer agrees may be repaired shall be cut back to sound concrete or to 75mm whichever is the greater distance. In the case of reinforced concrete the area shall be cut back to at least 25mm clear distance behind the reinforcement or to 75mm, whichever is the greater distance. The cavity shall have sides at right angles to the face of the concrete. After cleaning out with water and compressed air, a thin layer of cement grout shall be brushed on to the concrete surface in the cavity and it shall then be filled immediately with concrete of the same class as the main body but with aggregate larger than 20mm nominal size removed. A form shall be used against the cavity, provided with a lip to enable concrete to be placed. The form shall be filled to a point above the top edge of the cavity.

After seven days the lip of concrete shall be broken off and the surface ground smooth. Surface irregularities which are outside the limits of tolerance set out in Clause 410 shall be ground down in the manner and to the extent instructed by the Engineer.

Severe honeycombing and defects other than those mentioned above shall be dealt with as instructed by the Engineer.

BB. FORMWORK

FORMWORK FOR CONCRETE

Definitions

Formwork means the surface against which concrete is placed to form a face, together with all the immediate supports to retain it in position while concrete is placed.

False work means the structural elements supporting both the formwork and the concrete until the concrete becomes self supporting.

A formed face is one which has been cast against formwork.

An exposed face is one which will remain visible when construction has been completed.

CONSTRUCTION OF FORMWORK AND FALSEWORK

Before construction begins, the Contractor shall submit to the Engineer, drawings showing details of the proposed formwork and false work.

Formwork and false work shall be so constructed that they will support the loads imposed on them by the fresh concrete together with additional stresses imposed by vibrating equipment and by construction traffic, so that after the concrete has hardened the formed faces shall be in the positions shown on the drawings within the tolerances set out in Clause 506.

Ground supports shall be properly founded on footings designed to prevent settlement.

Joints in formwork for exposed faces shall, unless otherwise specified, be evenly spaced and horizontal or vertical and shall be continuous or form a regular pattern.

All joints in formwork including formwork for construction joints shall be tight against the escape of cement, water and fines. Where reinforcement projects through formwork, the form shall fit closely round the bars.

Formwork shall be so designed that it may be easily removed from the work without damage to the faces of the concrete. It shall also incorporate provisions for making minor adjustments in position if required, to ensure the correct location of concrete faces. Due allowance shall be made in the position of all formwork for movement and settlement under the weight of fresh concrete.

Where overhangs in formwork occur, means shall be provided to permit the escape of air and to ensure that the space is filled completely with fully compacted concrete.

Formwork shall be provided for concrete surfaces at slopes of 30 degrees to the horizontal or steeper. Surfaces at slopes less than 20 degrees may be formed by screeding. Surfaces at slopes between 20 degrees and 30 degrees shall generally be formed unless the Contractor can demonstrate to the satisfaction of the Engineer that such slopes can be screeded with the use of special screed boards to hold the concrete in place during vibration.

Horizontal or inclined formwork to the upper surface of concrete shall be adequately secured against uplift due to the pressure of fresh concrete. Formwork to voids within the body of the concrete shall also be tied down or otherwise secured against floating.

The internal and external angles on concrete surfaces shall be formed with fillets and chamfers of the sizes shown on the drawings unless otherwise instructed by the Engineer.

Supports for formwork for non-water retaining structures may be bolted to previously placed concrete provided the type of bolt used is acceptable to the Engineer. If metal ties through the concrete are used in conjunction with bolts, the metal left in shall not be closer than 50mm to the face of the concrete.

Supports for formwork for water retaining structures may be bolted to previously placed concrete provided the type of bolts and positions of fixing are acceptable to the Engineer. After concreting the Contractor shall remove all support bolts and seal all holes with well rammed cement/sand mortar containing approved waterproofing cement additive. Metal ties which would be left in the concrete shall not be permitted.

Formwork shall not be re-used after it has suffered damage which in the opinion of the Engineer is sufficient to impair the finished surfaces of the concrete.

openings for this purpose shall be provided through the formwork.

Shear keys shall be provided in all construction joints of the size and shape indicated on the drawings.

Where precast concrete elements are specified for use as permanent formwork, or proposed by the Contractor and agreed by the Engineer, they shall comply with the requirements of the Specification. Such elements shall be set true to line and level within the tolerances prescribed for the appropriate class of finish in Clause 506 and fixed so that they cannot move when concrete is placed against them.

PREPARATION OF FORMWORK

Before any reinforcement is placed into position within formwork, the latter shall be thoroughly cleaned and then dressed with a release agent. The agent shall be either a suitable oil incorporating a wetting agent, an emulsion of water suspended in oil or a low viscosity oil containing chemical agents. The Contractor shall not use an emulsion of oil suspended in water nor any release agent which causes staining or discoloration of the concrete, air holes on the concrete surface, or retards the set of the concrete.

In order to avoid colour difference on adjacent concrete surfaces, only one type of release agent shall be used in any one section of the works.

In cases where it is necessary to fix reinforcement before placing formwork, all surface preparation of formwork shall be carried out before it is placed into position. The Contractor shall not allow reinforcement or prestressing tendons to be contaminated with formwork release agent.

Before placing concrete all dirt, construction debris and other foreign matter shall be removed completely from within the placing area. Before concrete placing commences, all wedges and other adjusting devices shall be secured against movement during concrete placing and the Contractor shall maintain a watch on the formwork during placing to ensure that no movement occurs.

REMOVAL OF FORMWORK

Formwork shall be carefully removed without shock or disturbance to the concrete. No formwork shall be removed until the concrete has gained sufficient strength to withstand safely any stresses to which it may thereby be subjected.

The minimum periods which shall elapse between completion of placing concrete and removal of forms are given in Table 5.1 and apply to ambient temperatures higher than 10 degrees centigrade. At lower temperatures or if cement other than ordinary Portland are involved, the Engineer may instruct that longer periods be used.

Alternatively, formwork may be removed when the concrete has attained the strength set out in Table 5.1, provided that the attained strength is determined by making test cubes and curing them under the same conditions as the concrete to which they refer.

Compliance with these requirements shall not relieve the Contractor of his obligation to delay removal of formwork until the removal can be completed without damage to the concrete.

Table 5.1 - MINIMUM PERIODS FOR FORMWORK REMOVAL

Position of Formwork	Min. period for temp over 10 degrees Centigrade	Strength to be attained
Vertical or near vertical faces of mass concrete	24 hours	0.2 C
Vertical or near vertical faces of reinforced walls, beams and columns	48 hours	0.3 C
Underside of arches, beams and slabs (formwork only)	4 days	0.5 C

Supports to underside of arches, beams and slabs	14 days	C
Arched linings in tunnels and underground works	24 hours	4 N/mm ²

Note: C is the nominal strength for the class of concrete used.

If the Contractor wishes to strip formwork from the underside of arches, beams and slabs before the expiry of the period for supports set out above, it shall be designed so that it can be removed without disturbing the supports. The Contractor shall not remove supports temporarily for the purpose of stripping formwork and subsequently replace them.

As soon as the formwork has been removed, bolt holes in concrete faces other than construction joints which are not required for subsequent operations shall be completely filled with mortar sufficiently dry to prevent any slumping at the face. The mortar shall be mixed in the same proportions as the fine aggregate and cement in the surrounding concrete and with the same materials and shall be finished flush with the face of the concrete.

SURFACE FINISHES ON FORMED SURFACES

Classes of finish

The surface finish to be achieved on formed concrete surfaces shall be as shown on the drawings and defined hereunder:-

a) Class F1 finish

This finish is for surfaces against which backfill or further concrete will be placed. Formwork may be sawn boards, sheet metal or any other suitable material which will prevent the loss of fine material from the concrete being placed.

b) Class F2 finish

This finish is for surfaces which are permanently exposed to view but where the highest standard of finish is not required. Forms to provide a Class F2 finish shall be faced with wrought thickened tongued and grooved boards with square edges arranged in a uniform pattern and close jointed or with suitable sheet material. The thickness of boards or sheets shall be such that there shall be no visible deflection under the pressure exerted by the concrete placed against them. Joints between boards or panels shall be horizontal and vertical unless otherwise directed. This finish shall be such as to require no general filling of surface pitting, but fins, surface discoloration and other minor defects shall be remedied by methods agreed by the Engineer.

c) Class F3 finish

This finish is for surfaces which will be in contact with water flowing at high velocity, and for surfaces prominently exposed to view where good appearance is of special importance. To achieve this finish, which shall be free of board marks, the formwork shall be faced with plywood complying with B.S. 1088 or equivalent material in large sheets. The sheets shall be arranged in an approved pattern. Wherever possible, joints between sheets shall be arranged to coincide with architectural features or changes in direction of the surface.

All joints between panels shall be vertical and horizontal unless otherwise directed. Suitable joints shall be provided between sheets to maintain accurate alignment in the plane of the sheets. Unfaced wrought boarding or standard steel panels will not be permitted for Class F3 finish. The Contractor shall ensure that the surface is protected from rust marks, spillages and stains of all kinds.

d) Curved surfaces

For curved surfaces where F2 or F3 finishes are called for, the formwork face shall be built up of splines cut to make a tight surface which shall then be dressed to produce the required finish.

Alternatively, single curvature surfaces may be faced with plastic or plywood linings attached to the backing with adhesive or with escutcheon pins driven flush. Linings shall not bulge, wrinkle or otherwise deform when subjected to temperature and moisture changes.

TOLERANCES

All parts of formed concrete surfaces shall be in the positions shown on the drawings within the tolerances set out in Table 5.2.

In cases where the drawings call for tolerances other than those given in Table 5.2 the tolerances shown on the drawings shall take precedence.

Where precast units have been set to a specified tolerance, further adjustments shall be made as necessary to produce a satisfactory straight or curved line. When the Engineer has approved the alignment, the Contractor shall fix the units so that there is no possibility of further movement.

Table 5.2 - TOLERANCES

Class of finish	Tolerances in mm (See Note)		
	A	B	C
F1	10	10	+ 25 to - 10
F2	5	10	+ or - 15
F3	2	5	+ or - 10

Note: The tolerances A, B and C given in the table are defined as follows:

1. Column A is an abrupt irregularity in the surface due to misaligned formwork or defects in the face of the formwork.
2. Column B is a gradual deviation from a plane surface as indicated by a straight edge 3m long. In the case of curved surfaces, the straight edge shall be replaced by a correctly shaped template.
3. Column C is the amount by which the whole or part of a concrete face is displaced from the correct position shown on the drawings.

CC. MASONRY

GENERAL

All masonry work shall be constructed from building stone as specified in Clause 804.

For walls, facing and other exposed works the stone shall unless otherwise specified, be medium chisel-dressed.

WORKMANSHIP

The Contractor shall provide and use proper setting out rods for all work.

Stones shall be well soaked before use and the tops of walls shall be kept wet as the work proceeds. The stones shall be properly bonded so that no vertical joint in a course is within 115mm of a joint in the previous course. Alternate courses of walling at angles and intersections shall be carried through the full thickness of the adjoining walls. All perpend, reveals and other angles of the walling shall be built strictly true and square.

The stones shall be bedded, jointed and pointed in mortar 1 to 3 in accordance with Clause 707 with beds and joints 9mm thick flushed up and grouted solid as the work proceeds.

All masonry work shall be cured in accordance with the relevant requirements of Clause 406.

DD. CAST STONWORK

Cast stone shall be as specified in Clause 711. Facing stones shall be brought up in courses to a height not exceeding 1 metre at a time, the concrete backing being then brought up and well incorporated into and round the backs of the stones and the projecting metal ties to ensure a complete bond. The stones shall be bedded and jointed as shown on the drawings.

All materials, moulds, mixing, casting and surface treatment, setting, jointing and pointing, and all centering, scaffolding and labour required to complete the cast stonework specified or as shown on the drawings, shall be included in the rates for such work.

EE. MATERIALS

GENERAL

The approval in writing or otherwise by the Engineer of any materials shall not in any way whatsoever relieve the Contractor from any liability or obligation under the Contract and no claim by the Contractor on account of the failure, insufficiency or unsuitability of any such materials will be entertained.

- a) All items shall be suitable for water works purposes and for use with cold water installation and operation being in a tropical climate.
- b) All items hereinafter specified shall be to such other Standard or Specification which in the opinion of the Engineer provides for a quality of material and workmanship not inferior to the Standard Reference Number (SRN) quoted. The Standard or Specification must be submitted to the Engineer for approval before commencement of work.
- c) All ferrous pipes and fittings shall be coated with a protective paint suitable for use in and transport through a tropical climate.
- d) The Contractor shall supply to the Employer a certificate stating that each item supplied has been subjected to the tests hereinafter laid down and conforms in all respects to the said Specification.
- e) The Contractor shall provide adequate protection to all piping, flanged items and valves so as to guard effectively against damage in transit and storage and ingress of foreign matter inside the valves.
- f) All pipework and fittings shall be subjected to a works hydrostatic test pressure which shall be not less than twice the maximum operating pressure.
- g) The Contractor should exercise diligence to provide the best material.
- h) Where applicable the manufacturer's Specification should accompany all offers. The name of the manufacturer must in every case be stated.
- j) Where necessary the Contractor shall provide rubber gaskets to comply with SRN 208 and all other bolts, nuts, washers, etc. to undertake jointing at fittings etc.
- k) Any articles required under this Contract which are found to be faulty due to a crack, flaw or any other reason or is not in accordance with the Specification stipulated will not be accepted nor will the Employer be liable for any charges in respect of such an article. Where any such rejected article can, in the opinion of the Engineer, be rendered usable, the Contractor may deal with it accordingly and include it in the Contract at a price to be mutually agreed. Straight pipes which have been cut will be accepted at the discretion of the Engineer, provided the length is not less than 4 metres or two thirds of the standard length whichever is the lesser and will be priced pro-rata.

l) Wherever possible, samples of pipes and fittings shall be submitted for approval of the Engineer prior to the Contractor obtaining the total requirements.

FF. GALVANISED PIPES AND SPECIALS

All piping shall conform to SRN 823 and SRN 903 for “Medium” Piping. The pipes shall be screwed and socketed, coupled or flanged.

All specials shall be of such dimensions as will mate with the piping supplied. Screwdownstopvalves shall conform to SRN 826. Barrel nipples shall conform to SRN 823 and all other specials shall conform to SRN 824.

All pipes supplied shall be certified by the manufacturer to have been tested in accordance with the relevant Standard Specification.

GATE VALVES

Gate valves shall comply with the requirements of SRN 501.

The gate valves shall be suitable for use in pipelines and for the operating pressure to a head of 160 metres or 250 metres of water (NP 16) or NP 25.

The gate valves shall be double flanged. The dimensions and drilling of flanges shall be in accordance with SRN 207. Flanges shall be machined flat. Flanges shall be NP 16 / NP 25 complying with SRN 207.

Spindles of the gate valves shall be provided with cast iron caps conforming to the requirements as specified under “Valve Caps” in SRN 501 or handwheels if so specified.

The spindles of the gate valves shall be of the non-rising type and screwed so as to close the valves when rotated in a clockwise direction. The direction of closing shall be clearly cast on the valve cap or handwheel.

The gate valves shall be subject to “Closed End Tests” in accordance with the procedure set out in SRN 501.

The gate valves shall be suitable for opening and closing against an unbalanced head by manual operation.

GG.PAINTS

All priming, undercoating and finishing paints shall be in accordance with SRN 877 or SRN 878 as appropriate.

The painting of all building works shall comprise a special paint recommended for external work while all other paints, plastic emulsion coating etc. are to be of an approved manufacturer. All paints, distempers etc. shall be delivered on site intact in the original drums or tins, and shall be mixed and applied in accordance with the manufacturer’s printed directions. The only addition which will be allowed to be made will be liquid thinners, driers etc. supplied by the makers for the purpose.

All surfaces must be thoroughly cleaned down prior to painting and decorating work and no external painting shall be carried out in rainy weather. All paint must be thoroughly well worked on and excess of paint in any coat must be avoided.

All colours will be selected by the Engineer from the standard range of colours.

HH.PRECAST CONCRETE UNITS

Precast concrete covers to be precast units for use in the works, whether instructed under the Contract or proposed by the Contractor.

a) Formwork for Precast Units

Moulds shall be so constructed that they do not suffer distortion or dimensional changes during use and are tight against loss of cement grout or fines from the concrete.

Moulds shall be set up on firm foundations so that no settlement occurs under the weight of the fresh concrete.

Moulds shall be constructed so that units may be removed from them without sustaining any damage.

Release agents used for demoulding shall not stain the concrete or affect its properties in any way.

b) Reinforcement for Precast Units

Reinforcement in precast units shall comply with the requirement of Clauses 736 and 419-420. When preformed cages are used the cages shall be made up on jigs to ensure dimensional accuracy and shall be carefully supported within the mould in such a way that they cannot move when concrete is placed. Reinforcement complying with SRN 126 may be tack welded where bars cross to provide rigidity in the cage but reinforcement complying with SRN 127 shall not be welded.

Cover to main reinforcement shall be as shown on the drawings, or if not shown shall be not less than 25mm or the diameter of the bar, whichever is the greater. Cover on distribution steel shall not be less than 15mm or the diameter of the bar whichever is the greater.

Bars shall be spaced so that the minimum clear distance between them is the maximum nominal aggregate size plus five millimetres but in any case not less than the diameter of the bars.

Bars may be placed in pairs provided that there are no laps in the paired lengths.

c) Casting of Units

Concrete for precast units shall comply with Clauses 724 and 401-410 using the class of concrete specified on the drawings.

If lightweight aggregates are specified, they shall comply with SRN 147.

The area in which units are cast shall be adequately protected from the weather so that the process is not affected by rain, sun or drying winds.

d) Curing Precast Units

Requirements for curing shall be generally as set out in Clause 407.

The Contractor shall ensure that units do not suffer any loss of moisture or sudden changes of temperature for at least four days after casting. If a water spray is used for curing, the water shall be at a temperature within 5 degrees centigrade of the temperature of the unit being cured.

If Contractor proposes curing at elevated temperatures, the method shall be subject to the agreement of the Engineer and shall include means whereby units are heated and subsequently cooled evenly without sudden changes of temperature.

e) Dimensional Tolerances of Precast Units

Units shall be accurately formed to the dimensions shown on the drawings unless closer tolerances are called for by the Engineer.

f) Surface Finish of Precast Units

The formed faces of precast units shall be finished to Class F3 as set out in Clause 505(C) unless another class of finish is specified on the drawings.

Free faces shall be finished to Class UF2 unless another class of finish is specified on the drawings.

In cases where a special finish is required a trial panel shall be constructed by the Contractor which after approval by the Engineer shall be kept available for inspection at the place of casting and production units shall thereafter match the approved pattern.

Those parts of the unit which are to be joined to other units or to in-situ concrete shall be brushed with a stiff brush before the concrete has fully hardened. Alternatively, if the concrete has been allowed to harden, the surfaces shall be roughened by sand blasting or by the use of a needle gun.

g) Handling and Storage of Precast Units

Precast units shall be handled in a manner which will not cause damage of any kind and shall be stored on a hard impermeable base.

Prestressed units and large precast normally reinforced units shall be handled and stored so that no stresses shall be induced in excess of those which they will incur in their final positions in the Works unless they have been designed to resist such stresses.

Units shall be provided with adequate lifting holes or loops, placed in the locations shown on the drawings or agreed by the Engineer and they shall be lifted only by such holes or loops. Where it is not possible to provide holes or loops, suitable sling positions shall be indicated in paint on the units.

Units shall be marked indelibly with the reference number and date of casting and shall be stacked on suitable packers which will not damage the concrete or stain the surfaces. Not more than two packers shall be placed under each unit and these shall be located either at the positions of the permanent support points or in positions such that the induced stresses in the unit will be a minimum.

g) Testing Precast Units

Precast units shall be capable of safely sustaining the loads which they have been designed to carry. The Contractor shall subject units selected by the Engineer to load tests simulating the working conditions. Details of such tests shall be agreed between the Engineer and the Contractor.

In the case of units subject to bending loads the test piece shall be supported at full span and a loading equivalent to 1.25 times the sum of the live and dead loads which were assumed in the design shall be maintained for one hour without the appearance of any signs of distress. The recovery one hour after the removal of load shall be not less than 75 per cent of the full load deflection.

If the unit fails to meet the above requirements, further tests shall be carried out on two more units. If either of these fail the whole batch of units will be rejected.

If the Engineer so requires, a test to destruction shall also be carried out which on units subject to bending shall be as follows:-

The units shall be supported at full span and a load applied in increments instructed by the Engineer up to 95 per cent of the designed ultimate load. This load shall be held for 15 minutes without failure of the unit. The deflection at the end of this period shall be not more than 1/40th of the span. The load shall then be further increased until failure occurs.

If the unit fails to sustain the required load for the prescribed period or if the deflection exceeds the specified amount, the Engineer may order two further tests, and if either of these fail, the batch of units which they represent may be rejected.

II. SUBMISSION OF SAMPLES

As soon as possible after the contract has been awarded, the Contractor shall submit to the Engineer a list of the suppliers from whom he proposes to purchase the materials necessary for the execution of the Works. Each supplier must be willing to admit the Engineer or his representatives, to his premises during ordinary working hours for the purpose of obtaining samples of the materials in question. Alternatively, if desired by the Engineer, the Contractor shall deliver the samples of the materials to the Engineer's office without charge.

The information regarding the names of the suppliers may be submitted at different times, as may be convenient, but no source of supply shall be changed without the Engineer's prior approval once a supplier, source or material has been approved.

Samples of materials approved will be retained at the Engineer's office until the completion of the contract. Samples may be tested to destruction.

All materials delivered to site must be at least equal in all respects to approved samples, otherwise they shall be rejected. No special payment will be made for compliance with clauses specifying tests etc. to ensure quality control etc. unless specifically itemised in Bills of Quantities.

JJ. MATERIALS FOR CONCRETE

a) General

The Contractor shall submit to the Engineer full details of all materials which he proposes to use for making concrete. No concrete shall be placed in the Works until the Engineer has approved the materials of which it is composed. Approved materials shall not thereafter be altered or substituted by other materials without the consent of the Engineer.

b) Cement

Cement shall comply with the following Kenya Standards:- SRN

103 for Ordinary Portland cement.

SRN 103 for Rapid Hardening Portland cement plus all special conditions to its use stipulated by the manufacturer.

SRN 104 for Sulphate Resisting or High Alumina cement.

Cement shall be free flowing and free of lumps. It shall be supplied in the manufacturer's sealed unbroken bags or in bulk. Bagged cement shall be transported in vehicles with effective means of ensuring that it is protected from the weather.

Bulk cement shall be transported in vehicles or in containers specially built and equipped for the purpose.

Cement in bags shall be stored in a suitable weatherproof structure of which the interior shall be dry and well ventilated at all times. The floor shall be raised above the surrounding ground level and shall be so constructed that no moisture rises through it.

Each delivery of cement in bags shall be stacked together in one place. The bags shall be closely stacked so as to reduce air circulation but shall not be stacked against an outside wall. If pallets are used, they shall be constructed so that bags are not damaged during handling and stacking. No stack of cement bags shall exceed 3 metres in height. Different types of cement in bags shall be clearly distinguished by visible markings and shall be stored in separate stacks.

Cement from broken bags shall not be used in the Works. Cement in

bags shall be used in the order in which it is delivered.

Bulk cement shall be stored in weatherproof silos which shall bear a clear indication of the type of cement

contained in them. Different types of cement shall not be mixed in the same silo.

The Contractor shall provide sufficient storage capacity on site to ensure that his anticipated programme or work is not interrupted due to lack of cement.

Cement which has become hardened or lumpy or fails to comply with the Specification in any way shall be removed from the site.

All cement for any one structure shall be from the same source.

Cement which is stored on site for longer than one month shall be rejected.

c) Fine Aggregate

Fine aggregate shall be clean, hard and durable and shall be natural sand, crushed gravel sand or crushed rock sand complying with SRN 108. All the material shall pass through a 5mm standard sieve and the grading shall be in accordance with Zones 1, 2 or 3 of SRN 109. In order to achieve an acceptable grading, it may be necessary to blend materials from more than one source. Fine aggregate for mortar only shall comply with SRN 135.

The fine aggregate shall not contain iron pyrites or iron oxides. It shall not contain mica, shale, coal or other laminar, soft or porous materials or organic matter unless the Contractor can show by comparative tests, on finished concrete as set out in SRN 117, that the presence of such materials does not adversely affect the properties of the concrete.

d) Coarse aggregate

Coarse aggregate shall be clean, hard and durable crushed rock, crushed gravel or natural gravel complying with the requirements of SRN 110. The material shall not contain any iron pyrites, iron oxides, flaky or laminated material, hollow shells, coal or other soft or porous material, or organic matter unless the Contractor can show by comparative tests on finished concrete as set out in SRN 117 that the presence of such materials does not adversely affect the properties of the concrete. The pieces shall be angular, rounded or irregular as defined in SRN 107.

Coarse aggregate shall be supplied in the nominal sizes called for in the Contract and shall be graded in accordance with SRN 111 for each nominal size.

f) Delivery and storage of aggregates

Aggregates shall be delivered to site in clean and suitable vehicles. Different types or sizes of aggregate shall not be delivered in one vehicle.

Each type or size of aggregate shall be stored in a separate bin or compartment having a base such that contamination of the aggregate is prevented. Dividing walls between bins shall be substantial and continuous so that no mixing of types or sizes occurs.

The storage of aggregates shall be arranged so that as far as possible rapid drying out in hot weather is prevented in order to avoid sudden fluctuations in water content. Storage of fine aggregates shall be arranged so that they can drain sufficiently before use in order to prevent fluctuations in water content of the concrete.

g) Water for concrete and mortar

Sea water or brackish water containing more than 1,000 ppm chloride ion or 2,000 ppm sulphate ion shall not be used for mixing or curing concrete.

Water shall be clean and free from harmful matter and shall comply with the requirements of SRN 114.

The Contractor shall carry out tests in accordance with SRN 114 to establish compliance with the Specification.

KK. BUILDING STONE

All building stone shall be capable of withstanding when wet a crushing stress of 1.4 kg./sq.mm. The source of stone shall be approved by the Engineer and stone supplied therefrom shall be free from Magadi, overburden, mudstone, cracks, sand holes, veins, laminations or other imperfections.

The stone shall be chisel dressed into true rectangular blocks, with each surface even and at right angles to all adjoining surfaces, to the size specified. For exposed stonework the maximum permissible variation of any of the specified dimensions shall be 6mm provided that cut stone, supplied as 'rock face' stone may be hammer dressed on one face only, or on one face and one end, if in other respects it conforms with this specification. Stones shorter than 375mm will not be accepted.

Unless the Engineer allows otherwise the Contractor shall at his own expense provide and dress four 100mm cubes of stone for testing.

The stone shall be sound when tested in accordance with SRN 870 except that:-

- i) The treatment shall be repeated for 10 cycles only; and
- ii) The second criterion of failure shall be amended to allow for a loss of weight of not more than 20% of its original weight.

MURRAM

Murram shall be from an approved source quarried so as to exclude vegetable matter, loam, top soil or clay. The California Bearing Ratio of the murram, as determined for a sample compacted to maximum density (as defined under SRN 601) and allowed to soak in water for four days, shall not be less than 30%. This C.B.R. is a guide to quality only and the compaction in the work will be judged by density.

LL. CEMENT MORTAR

Cement mortar shall consist of proportions by volume as specified of Portland Cement and natural sand or crushed natural stone or a combination of both as specified in SRN 135 and SRN 136 : Building Sands from Natural Sources. The constituent materials shall be accurately gauged and mixed in an approved manner.

Cement mortar shall be made in small quantities only as and when required, and any mortar which has begun to set or which has been mixed for a period of more than one hour shall be rejected.

MM. CONCRETE BLOCKS

Solid and hollow concrete blocks for walling shall comply with SRN 904 in every respect.

All solid and hollow concrete blocks used in the walling must be capable of withstanding a crushing pressure of not less than 0.35 kg per square millimeter after 28 days. The blocks shall be cast in Metric sizes.

NN. TESTING OF MATERIALS AND WORKMANSHIP

APPARATUS REQUIRED FOR TESTING ON SITE

Apparatus for testing shall be, if directed by the Engineer, made available on site of the works, for as long a period as required by the Engineer, and regarded as constructional plant. The Contractor to allow for this provision in his rates. The following may be required:-

- a) A set of sieves complying with British Standard 410 : Test Sieves, or the following nominal sizes:-

Fine mesh wire cloth 200, 100, 72, 52, 36, 25, 18, 14, 10 and 7.

Medium mesh wire cloth 3mm.

Perforated plate 5mm, 6mm, 9mm, 12mm, 20mm, 38mm, 50mm, 65mm and 75mm.

- b) A suitable balance, a pycnometer and a stove or other approved apparatus for determining the moisture content of the aggregate. The methods of test shall be as described in Part Four of British Standard 812: Sampling and Testing of Mineral Aggregates, Sands and Fillers.
- c) A 200 ml. graduated cylinder in accordance with British Standard 604: Graduate Measuring Cylinders, for the use in the field settling test for clay and fine silt in aggregates.
- d) Two 0.34 kg. graduated clear glass medicine bottles for use in the test of organic impurities in sand.
- e) Apparatus required for testing soils in accordance with British Standard 1377: Methods of Test for Soil Classification and Compaction, and British Standard 1924: Methods of Test for Stabilised Soils.
- f) Apparatus for testing concrete in accordance with British Standard 1881: Methods of Testing Concrete, Parts 1 to 7.
- g) A straight edge 3 meters long and measuring wedge or other approved apparatus for testing the accuracy of surfaces.

Additional testing equipment as stated in the Bill of Quantities or as required by the Engineer.

LOAD TESTING OF PIPES

The Engineer may instruct the Contractor to make a Loading Test (Three-Edge Bearing or Sand Bearing) on pipes to be used to construct the sewer. Payment for Load Tests will be entirely in accordance with the General Conditions of Contract.

OO. MISCELLANEOUS

RR.1 GALVANISED WORK

Iron and steel, where galvanised, shall comply with B.S. 729, entirely coated with zinc after fabrication by complete immersion in a zinc bath in one operation and all excess carefully removed. The finished surface shall be clean and uniform.

RR.2 PAINT AND PAINTING

All paint, including primers, undercoats and finishings, polish, emulsion etc., to be used shall be obtained ready for use from the manufacturer approved by the Engineer.

The Contractor shall order direct from the manufacturer and only fresh paint will be allowed to be used.

All paints shall be of the qualities, i.e. exterior, interior etc., types and colours scheduled. All coats of paint system shall be obtained from the same manufacturer, shall be ordered for use together and as far as practicable, shall be ordered on one order in sufficient quantity for the whole of the work, particularly in the case of the finishing colour. Where more than one of the three systems (gloss, semi-gloss or flat) is in use, these paints shall be used in strict accordance with their accompanying printed instructions.

The Contractor shall use only paints delivered to the site in original sealed containers, not exceeding five liter capacity, stamped and bearing the manufacturer's name of mark, the specification number, method of application (e.g. brushing) colour, quantity, batch number and date of manufacture, and expiry.

Contractor's stocks shall not be accepted unless expressly approved by the Engineer's Representative.

The paint, which will be subject to sampling and testing, shall be used exactly as received, after adequate stirring, without the addition of thinners, driers, or adulterating materials of any kind.

All tints and shades (including colours of undercoats) shall be selected and approved by the Engineer's Representative and the Contractor shall allow in his prices for executing the painting work in colour schemes, to

be prepared from a wide range of colours.

All paints described as oil paint shall be alkyd paint.

No painting on exterior work shall be carried out in wet weather or upon surfaces which are not thoroughly dry. Painting shall not proceed in dusty conditions. Each coat of paint shall be thoroughly dry and shall be rubbed down with glass paper before a subsequent coat is applied. Adequate care must be taken to protect surfaces of paintwork, still wet. Lead based priming paints for steelwork shall conform to B.S. 2521 and 25

Fairness, Transparency & Accountability

SECTION VII- BILLS OF QUANTITIES

BILL OF QUANTITIES FOR BEKIBON WATER SUPPLY PROJECT					
	ITEM DESCRIPTION	UNIT	QTY	RATE (Ksh.)	AMOUNT (Ksh.)
1.0	BILL No. 1 – PRELIMINERIES & GENERAL				
	The rates are inclusive of handling charges, levies, taxes mobilization and demobilization				
1.1.	Signboards				
	Allow sum for provision, erection and maintenance of signboard as directed by Engineer	No.	1		
1.2	Supervision of works by Engineer				
	Provide prime cost for Ksh.250,000 for, supervision to be expended as directed by Engineer to include checking levels, airtime, progress reports, photographs, publicity and community mobilization and sensitization	Item	1	250,000	250,000
1.3	Add percentage on items 1.2 above for administration	%			
	Total Carried to Summary– BILL No.1				
2	BILL No. 2 – INTAKE WORKS				
2.1	Weir & Spring Protection				
2.1.1	Allow for temporary works to divert spring water during construction. Spring discharge is estimated to be 2litres per second - diversion maybe done using 3" dia. Pipe	Item	1s		
2.1.1	Excavate for weir foundation and protection slab trench around the spring to firm formation in hard ground. Where necessary key the rocky parts to receive concrete as directed. Cart excavated material and deposit downstream	M3	4		
2.1.3	Plain concrete weir base 200 mm thick by 700 mm width to bottom of trench and	M3	0.7		
2.1.4	200mm thick by 450mm width plain concrete (1:3:6) in spring protection wall foundation around the spring	M3	1.1		
2.1.5	Provide and place R.C. Concrete (1:2:4) mixed with water proof cement in weir, wing walls, protection slab roof and walls to detail as provided in the drawings	M3	12		
2.1.6	Provide R.C. off-take chamber of internal dimensions 1mx1mx 1.2m high to flush with the top of the protection spring weir.	M3	0.5		
2.1.7	Fabricate for ditto access manhole cover made of 4mm steel sheet complete with frame of 1m by 1m	No.	1		
2.1.8	100 mm thick plain floor concrete slab for chamber	M3	0.2		

2.1.9	25 mm uPVC pipes embedded in chamber as perforations carefully arranged in the wall @ 200mm intervals both ways starting 600mm from chamber bottom	No.	3		
2.1.10	Provide, cut and fix formwork to sides of the weir, wing walls and protection roof	M2	26		
2.1.11	Provide, cut and fix formwork for support pillars	M2	6		
2.2	weir & Chamber				
	Reinforcements: Supply, transport, cut, bend and fix the following. Include for tying				
2.2.1	10mm Ø in weir & wing walls (30 No.)	Kg	320		
2.2.2	12mm Ø in protection roof and pillars (45No.)	Kg	760		
2.2.3	6mm Ø for general use (6 No.)	Kg	8		
2.2.4	Provide 600x500 mm lockable manhole cover to chamber fabricated using 4mm mild steel sheet	No.	1		
2.2.5	Fabricate screen for 80mm ø GS off-take pipe or provide suitable foot valve to ensure clean water in gravity pipe	No.	1		
2.3	Pipes & Fittings:				
	Provide and lay/ fix the necessary pipes & fittings to Engineers satisfaction follows: (Prices to include necessary pipe threading, cutting and joining Materials)				
2.3.1	100mm ø GS socketed Class "B" Scour Pipe	No.	1		
2.3.2	100mm ø GI Plug	No.	1		
2.3.3	80mm ø GS socketed Class "B" off-take & overflow Pipe	No.	1		
2.3.4	80mm ø Sluice Valve	No.	1		
2.3.5	80mm ø GS socketed Class "B" off-take Pipe	No.	3		
2.4	Gabion Protection Works - Upstream				
	Provide Gabion boxes of size 1mx1mx2m, level ground, lay, fill with natural stones and fasten with binding wire. The gabion boxes are to be laid above the protected spring to prevent any erosion that may be caused by storm water. This will be done to satisfaction of Engineer				
2.4.1		No.	10		
	Total Carried to Summary – Bill No.2				
3	BILL No. 3 –Gravity Main to Sump (300m)				
	PIPES & FITTINGS:				
	Supply, install and test 80mm diameter G.I socketed Class "B" Pipe				
3.1		M	300		
3.2	80mm socket union	No.	1		
3.3	80mm ø gate valve-peglar	No.	1		
3.4	80mm ø GS Hex nipple	No.	2		

3.5	80mm ø GS bend 90	No.	2		
3.6	80mm ø GS bend 45	No.	2		
3.7	80mm ø GS bend 22.5	No.	2		
3.8	80mm ø GS elbow	No.	2		
3.9	80mm ø GS equal tee	No.	1		
3.10	80mm ø GS G.I Plug	No.	2		
3.11	80mm ø GS V.J coupling	No.	5		
	Total Carried to Summary – Bill No.3				
4	BILL NO.4-RISING MAIN				
4.1	Supply pipes, install and test 50mm diameter class B pipeline. Rates to include light bush clearing all the necessary fittings	No	1300		
4.2	Supply install and test 25mm double orifice airvalve	No	1		
4.3	Supply materials and construct standard locable valve chamber measuring 1mx1mx1m	No	1		
4.4	Supply materials and construct anchor post to support the pipeline	No	12		
	Total Carried to Summary – Bill No.4				
5	BILL NO.5- CATTLE TROUGH (5mx1m) AND COMMUNAL WATER POINT				
4.1	Clearance of trough area and removal of trees and stumps	M ²	37		
4.2	Excavate over site soil material to reduce levels not exceeding 225mm deep and cart away	M ²	37		
4.3	Excavation for raft foundation 300mm deep starting from reduced levels.	M ³	2.5		
4.4	225 mm thick approved hardcore filling, leveled and compacted in 150mm layers.	M ²	17		
4.5	Level and blind surface of hardcore with 50mm thick 1:4:8 concrete mix blinding.	M ²	17		
4.6	Formwork to sides of floor slab 150mm thick	M ²	4		
4.7	Floor slab reinforcement A142.	M	6		
4.8	Insitu reinforced concrete:(mix 1:2:4) grade 20(20 mm aggregate):vibrated in foundation strip 150mm thick	M ³	1.27		
4.9	6"x9" approved local stone; squared; and rough chisel dressed one side, bedding and jointing in cement mortar (1:3) in Walls 150mm Thick	M ²	8		
4.10	Reinforcement bars Y8. include for tying to walling	Kg	12.5		

4.11	Plaster; 9mm first coat of cement:sand (1:3) steel troweled in 25 mm thick 2 No. Coatwork to sides of cattle trough internally. Include for water proofing	M ²	12.5		
4.12	Plaster; 9mm first coat of cement:sand (1:3) steel troweled in 25 mm thick 2 No. Coatwork to sides of cattle trough externally	M ²	8.5		
4.13	Supply, deliver to site approved hardcore, place and join with 1:3 cement mortar to form grouted riprap as directed. Include for leveling. (this includes also for the existing watering trough)	M ²	25		
4.14	Fabricate and install a 700mmx1000mm lockable 16g steel plate manhole hole cover framed and cross reinforced with 16g, 25mm hollow section steel cover.	No.	1		
4.15	50mm Ø elbow	No.	2		
4.16	50x25mm Ø reducing socket	No.	1		
4.17	25mm Ø long nipple	No.	1		
4.18	25mm Ø plain socket	No.	1		
4.19	25mm Ø ball valve pegler	No.	1		
4.20	Supply materials and construct communal water point with 4No. taps	item	ls		
	Sub -total -Bill NO. 5-Cattle trough and Communal water point				
6	BILL No. 6 – 50m³ Masonry Sump				
6.1	Masonry Sump				
	Provide materials and construct 50m ³ Masonry Sump/Tank below constructed weir as directed by Engineer/ supervisor. As per the Attached Drawing				
6.1.1	As per the Attached Drawing	No.	1		
6.1.2	General site clearance and setting out	M2	52		
6.1.3	Excavate oversight 200mm to remove vegetable soil and remove from site.	M2	52		
6.1.4	Excavate pit foundation to a depth not exceeding 1m.	M3	41		
6.1.5	Excavate pit foundation to a depth exceeding 1m but not exceeding 1.5m	M3	25		
6.1.6	Extra over excavation for excavating in rock	M3	3		
6.1.7	Backfill with selected excavated material as directed	M3	42		
6.1.8	Dispose excavated material as directed	M3	25		
6.2	Tank Construction				
6.2.1	Supply materials, transport to site, fill and compact 300mm thick approved hardcore materials on tank foundation base.	M3	9		

6.2.2	Supply materials, transport, place and compact 50mm thick concrete class 15 blinding to hardcore.	M2	29		
6.2.3	Supply, transport, cut, bend and fix D-10 bars in floor slab.	Kg	240		
6.2.4	Supply materials, transport, place and compact concrete class 25 in tank floor slab.	M3	5		
6.2.5	Supply materials and construct 225mm circular masonry wall in 1:3 sand/cement mortar finished with steel finished on one side.	M2	58		
6.2.6	Supply, transport, cut, bend and fix D-8 bars in wall.	kg	200		
6.2.7	Supply materials and construct formwork to soffit of roof slab exceeding 3.5m in height.	M2	20		
6.2.8	Supply materials and construct formwork to sides of roof slab 200mm thick exceeding 3.5m in height.	m	18		
6.2.9	Supply, transport, cut, bend and fix D- 10 bars to roof slab	Kg	252		
6.2.10	Supply material and place concrete class 25 to roof slab. Include fixing 24" x 24" steel manhole cover with frame.	M3	5		
6.2.11	Allow for application of three coats of approved bitumen paint to 300mm thick walling line on floor slab	m	17		
6.2.12	Allow for application of three coats of approved bitumen paint to 225m thick walling top before placing of roof slab	m	17		
6.2.13	Allow for application of 25x 25mm bondex at the inside corner between the wall base and the floor slab	m	16		
6.2.14	Supply material and place 25mm thick cement sand 1:2 screed with steel float finish. Mix to include approved water proof cement in the ratio of 1kg water proof to 50kg ordinary portland cement.	M2	20		
6.2.15	Supply material and plaster internal tank surfaces with 25mm thick cement sand 1:2 screed with steel float finish. Mix to include approved water proof cement in the ratio of 1kg water proof to 50kg ordinary portland cement.	M2	55		
6.2.16	Supply material and render external tank surfaces with 25mm thick cement sand 1:2 screed with wooden float finish.	M2	60		
6.2.17	Supply material and place cement sand 1:2 screed with wooden float finish to top of roof slab rising from 15mm at the edge of roof slab to 25mm at the centre of roof slab	M2	25		
6.3	Pipe And Fittings				
	All pipes to be Galvanized Iron with Screw unless specified otherwise				
6.3.1	Inlet				

6.3.1.1	80mm Ø drilled Flange complete with bolts, uts and gasket	No	4		
6.3.1.2	80mm Ø Sluice valve complete with bolts ,nuts and gasket	No	1		
6.3.1.3	80mm Ø 900 GI bend	No.	2		
6.3.1.4	80mm Ø long barrel nipple	No.	1		
6.3.1.5	80mm ball valve	No.	1		
6.3.1.6	80mm Ø G.I socket	No	2		
6.3.1.7	80mm G.I class B Pipe	No	1		
6.3.2	Off Take				
6.3.2.1	100 x 80mm G.I reducing socket	No	1		
6.3.2.2	80mm Ø drilled Flange complete with bolts, nuts and gasket	No	4		
6.3.2.3	80mm Ø Sluice valve complete with bolts nuts and gasket	No	1		
6.3.2.4	80mm Ø 900 GI bend	No.	2		
6.3.2.5	80mm Ø long barrel nipple	No.	1		
6.3.2.6	80mm Ø G.I socket	No	1		
6.3.2.7	80mm G.I class B Pipe	No	1		
6.3.3	Scour				
6.3.3.1	100 x 80mm G.I reducing socket	No	1		
6.3.3.2	80mm Ø drilled Flange complete with bolts, nuts and gasket	No	4		
6.3.3.3	80mm Ø Sluice valve complete with bolts nuts and gasket	No	1		
6.3.3.4	80mm Ø x 900 G. I bend	No.	2		
6.3.3.5	80mm Ø long G.I barrel nipple	No.	1		
6.3.3.6	80mm Ø G .I socket	No	1		
6.3.3.7	80mm G,I class B Pipe	No	1		
6.3.4	Overflow				
6.3.4.1	100 x 80mm G.I reducing socket	No	1		
6.3.4.2	80mm Ø drilled Flange complete with bolts, uts and gasket	No	2		
6.3.4.3	80mm Ø 900 GI bend	No	3		
6.3.4.4	80mm Ø long barrel nipple	No	2		
6.3.4.5	80mm Ø G.I socket	No	2		
6.3.4.6	80mm G.I Medium grade Pipe	No	1		
6.3.5	Vents 4No				
6.3.5.1	100mm Ø 900 GI Elbow	No	4		
6.3.5.2	100mm Ø long barrel nipple with wall purrs welded as directed	No	4		
6.3.5.3	100mm Hexagonal nipple	No	4		
6.3.5.4	100mm Ø 900 GI Elbow with mosquito wire fixed to one end	No	4		
6.3.6	Miscellaneous				
6.3.6.1	Supply materials, fabricate, and fix to wall and floor a 40mm dia. GI class B pipe ladder with 25mm G.I class B rungs at 300mm c/c welded to pipes	No	2		
6.3.6.2	Allow for restoring the site after construction of tank	1/sum	Item		
6.3.6.3	Allow for testing of tank water tightness	1/sum	Item		

6.3.6.4	Supply material construct masonry valve chamber of internal plan dimensions 1.0 x 1.0 x 1.5m	No	3		
	Total Carried to Summary– BILL No.6				
7	BILL No. 7 ~ 100m3 Tank				
7.1	Setting Out And Earth Works				
7.1.1	General site clearance and setting out	m2	61		
7.1.2	Excavate oversight 200mm to remove vegetable soil and remove from site.	m2	61		
7.1.3	Excavate pit foundation to a depth not exceeding 1m.	m3	49		
7.1.4	Excavate pit foundation to a depth exceeding 1m but not exceeding 1.5m	m3	31		
7.1.5	Extra over excavation for excavating in rock	m3	10		
7.1.6	Backfill with selected excavated material as directed	m3	50		
7.1.7	Dispose excavated material as directed	m3	41		
7.2	Tank Construction				
7.2.1	Supply materials, transport to site, fill and compact 300mm thick approved hardcore materials on tank foundation base.	m3	12		
7.2.2	Supply materials, transport, place and compact 50mm thick concrete class 15 blinding to hardcore.	m2	40		
7.2.3	Supply, transport, cut, bend and fix Y-10 bars in floor slab.	Kg	427		
7.2.4	Supply materials, transport, place and compact concrete class 25 in tank floor slab.	m3	7.5		
7.2.5	Supply materials and construct 225mm circular masonry wall in 1:3 sand/cement mortar finished with steel finished on one side.	m2	53		
7.2.6	Supply materials and construct 300mm circular masonry wall in 1:3 sand/cement mortar finished with steel finished on one side.	m2	32		
7.2.7	Supply, transport, cut, bend and fix Y-8 bars in wall.	kg	280		
7.2.8	Supply, transport, cut, bend and fix Y-10 bars in wall.	Kg	571		
7.2.9	Supply materials and construct formwork to soffit of roof slab exceeding 3.5m in height.	m2	30		
7.2.10	Supply materials and construct formwork to sides of roof slab 200mm thick exceeding 3.5m in height.	m	21		
7.2.11	Supply, transport, cut, bend and fix Y- 16 bars to roof slab	Kg	591		
7.2.12	Supply, transport, cut, bend and fix Y- 8 bars to roof slab	Kg	38		
7.2.13	Supply, transport, cut, bend and fix R - 6 bars to roof slab	Kg	17		

7.2.14	Supply material and place concrete class 25 to roof slab. Include fixing 24" x 24" steel manhole cover with frame.	m3	7		
7.2.15	Allow for application of three coats of approved bitumen paint to 300mm thick walling line on floor slab	m	20		
7.2.16	Allow for application of three coats of approved bitumen paint to 225m thick walling top before placing of roof slab	m	21		
7.2.17	Allow for application of 25x 25mm bondex at the inside corner between the wall base and the floor slab	m	19		
7.2.18	Supply material and place 25mm thick cement sand 1:2 screed with steel float finish. Mix to include approved water proof cement in the ratio of 1kg water proof to 50kg ordinary portland cement.	m2	29		
7.2.19	Supply material and plaster internal tank surfaces with 25mm thick cement sand 1:2 screed with steel float finish. Mix to include approved water proof cement in the ratio of 1kg water proof to 50kg ordinary portland cement.	m2	78		
7.2.20	Supply material and render external tank surfaces with 25mm thick cement sand 1:2 screed with wooden float finish.	m2	87		
7.2.21	Supply material and place cement sand 1:2 screed with wooden float finish to top of roof slab rising from 15mm at the edge of roof slab to 25mm at the centre of roof slab	m2	38		
7.3	Pipe And Fittings				
	All pipes to be Galvanized Iron with Screw unless specified otherwise				
7.3.1	Inlet				
7.3.1.1	80mm Ø drilled Flange complete with bolts, nuts and gasket	No	4		
7.3.1.2	80mm Ø Sluice valve complete with bolts ,nuts and gasket	No	1		
7.3.1.3	80mm Ø 900 GI bend	No.	2		
7.3.1.4	80mm Ø long barrel nipple	No.	1		
7.3.1.5	80mm Ø G.I socket	No	2		
7.3.1.6	80mm G.I class B Pipe	No	5		
7.3.1.7	80mm uPVC class E pipe	No	60		
7.3.2	Off Take				
7.3.2.1	100 x 80mm G.I reducing socket	No	1		
7.3.2.2	80mm Ø drilled Flange complete with bolts, nuts and gasket	No	4		
7.3.2.3	80mm Ø Sluice valve complete with bolts nuts and gasket	No	1		
7.3.2.4	80mm Ø 900 GI bend	No.	2		
7.3.2.5	80mm Ø long barrel nipple	No.	1		
7.3.2.6	80mm Ø G.I socket	No	1		
7.3.2.7	80mm G.I class B Pipe	No	1		

7.3.3	Scour				
7.3.3.1	100 x 80mm G.I reducing socket	No		1	
7.3.3.2	80mm Ø drilled Flange complete with bolts, nuts and gasket	No		4	
7.3.3.3	80mm Ø Sluice valve complete with bolts nuts and gasket	No		1	
7.3.3.4	80mm Ø x 900 G. I bend	No.		2	
7.3.3.5	80mm Ø long G.I barrel nipple	No.		1	
7.3.3.6	80mm Ø G .I socket	No		1	
7.3.3.7	80mm G,I class B Pipe	No		1	
7.3.4	Overflow				
7.3.4.1	100 x 80mm G.I reducing socket	No		1	
7.3.4.2	80mm Ø drilled Flange complete with bolts, uts and gasket	No		2	
7.3.4.3	80mm Ø 900 GI bend	No		3	
7.3.4.4	80mm Ø long barrel nipple	No		2	
7.3.4.5	80mm Ø G.I socket	No		2	
7.3.4.6	80mm G.I Medium grade Pipe	No		1	
7.3.5	Vents 4No				
7.3.5.1	100mm Ø 900 GI Elbow	No		4	
7.3.5.2	100mm Ø long barrel nipple with wall purrs welded as directed	No		4	
7.3.5.3	100mm Hexagonal nipple	No		4	
7.3.5.4	100mm Ø 900 GI Elbow with mosquito wire fixed to one end	No		4	
7.3.6	Miscellaneous				
7.3.6.1	Supply materials, fabricate, and fix to wall and floor a 40mm dia. GI class B pipe ladder with 25mm G.I class B rungs at 300mm c/c welded to pipes	No		2	
7.3.6.2	Allow for restoring the site after construction of tank	1/sum	Item		
7.3.6.3	Allow for testing of tank water tightness	1/sum	Item		
7.3.6.4	Supply material construct masonry valve chamber of internal plan dimensions 1.0 x 1.0 x 1.5m	No		3	
	Total Carried to Summary– BILL No.7				
8	BILL NO. 8 – Pump House				
8.1	Sub Structure				
8.1.1	Allow for maintaining and upholding the sides of excavations and keeping excavations free from all fallen materials,rubbish,etc.	Item		1	
8.1.2	Excavate over site average 200 mm deep, remove vegetable soil and deposit as directed.	m2		12	
8.1.3	Excavate foundation trench not exceeding 1.5 m deep.	m3		9.72	
8.1.4	Approved 300mmm thick hardcore fillings consolidated and rammed in 150mm thick layers to make up levels under slab base	m2		9	

8.1.5	Treat the surface of hardcore with approved insecticide	m2	9		
8.1.6	Concrete (1:3:6) to 450 x 150mm strip foundation	m3	1		
8.1.7	Concrete (1:4:8) in 50 mm thick blinding.	m2	9		
8.1.8	Concrete (1:3:6) 100 mm thick in floor slab	m2	11		
8.2	Walling and roofing				
8.2.1	150mm wide Bituminous damp proof course along external wall.	m	13.2		
8.2.2	Dressed solid natural stone wall bedded and jointed in sand: cement (1:3) 150 mm thick walling.	m2	37.02		
8.2.3	V.R.C (1:2:4) in 150 mm x 225 mm ring beam	m	13.2		
8.3	Roof				
8.3.1	Concrete (1:2:4) 100 mm thick in roof slab	m2	11		
8.3.2	Gable roof truss 0.6 m height. The trusses shall be made of timber size 3"x 2" and shall be properly strutted and brazed and fixed at 1.5 m center to center. The purlins shall be 4No. of timber 3"x 2".(All treated with approved wood preservative)	No.	3		
8.3.3	Pre-painted 28g corrugated roofing sheets fixed on timber purlins as described	m2	17		
8.3.4	Fix 200 mm wide fascia board	m	17		
8.3.5	Fix single flap steel door 1m x 2.1m	No.	1		
8.3.6	Fix casement window c/w glazing size 0.9 m L x 1.2 m H	No.	1		
8.4	Plastering				
8.4.1	12 mm thick two coat gauged plaster in cement: sand to walls internally	m2	33		
8.4.2	Key finish to external wall joints as directed.	m2	37		
8.4.3	12 mm thick two coat gauged plaster in cement: sand to floor	m2	9		
8.5	Formwork				
8.5.1	Sides of 150 mm x 225 mm lintels.	m	25.2		
8.5.2	Soffits of 150 mm x 225 mm lintels.	m	2.2		
8.5.3	Edges of 100mm roof slab	m	13.2		
8.5.4	Underneath roof slab	m2	9		
8.6	Reinforcement				
8.6.1	Steel reinforcement cut, bend & place in position, unit price to include cutting, bending & placing in position with binding wire and concrete seats				
8.6.1	10mm diameter high tensile steel in foundation wall	m	53		
8.6.2	8mm diameter high tensile steel in foundation wall	m	43		
8.6.3	12mm diameter high tensile steel in ring beam	m	51		
8.6.4	8mm diameter high tensile steel in ring beam	m	53		
8.6.5	12mm diameter high tensile steel in roof slab	m	160		

8.7	Paint work				
8.7.1	Apply 3 coat paint on internal walls	m2	37		
8.7.2	Apply 3 coat paint on 200mm fascia board with approved paint	m	17		
8.7.3	Apply 3 coat paint on steel door 1m x 2.1m with approved paint	m2	2.4		
8.7.4	Apply 3 coat paint on casement window c/w glazing size 0.9 m x 1.2 m with approved paint	m2	2.2		
	Total Carried to Summary– BILL No.8				
9	BILL No.9 – Pumping Unit				
9.1	Supply and install Three Phase surface Pump complete with 11KW motor capable of delivering 10m ³ /hr of water against a total head of 170m which will be solar driven . Rate to include all the necessary fittings and accessories and to be approved by the enfgineer.	No.	1		
9.2	Supply and install 15kw Solar Inverter or equivalent	No	1		
9.3	Supply and install Dayliff 330w Polycrystalline Module or equivalent	No	44		
9.4	Supply and install DC PV Disconnect Switch 1000VDC/40A	No	2		
9.5	Supply material and construct 4m High Mild steel Solar Support Structure (Drawing will be provided)	No	1		
	Total Carried to Summary– BILL No.9				
10	BILL No. 10 - Fencing - 200m perimeter				
10.1	Excavate for, provide and erect chain link fence 2.4m high comprising concrete posts set 0.9m below ground level with concrete class 15 (1:4:8) surround, concrete posts at 3.0m centres with 500mm long cranks at top, 12½ gauge chain link fence, 4 No. plain wire strands threaded through holes in posts, 4 No. strands 12½ gauge barbed wire tied to cranked top offence and weave to form mesh, concrete strutting posts at corners and intervals as appropriate and as shall be directed by the Engineer. The rate to include for all the necessary excavation and disposal.	m	200		
10.2	Provide and install double gate of 4m wide X 2.4m high fabricated from dia. 50mm hollow section black pipes (gauge 16) .and 25mm x 25mm Square tubes cut and welded to form a mesh 150mm X 150mm Rate to include for 2No. 80mm x 80mm gauge 16 rectangular hollow section M.S. Gate posts and also to include for painting the gate with oxide primer and two coats of blue gloss paint	No.	1		

Total Carried to Summary– BILL No.10				
BILL No. 1 – PRELIMINERIES & GENERAL				
BILL No. 2 – INTAKE WORKS				
BILL No. 3 –Gravity Main to Sump (180m)				
BILL No. 4 – Rising Main				
BILL NO.5- CATTLE TROUGH (5mx1m) AND COMMUNAL WATER POINT				
BILL No. 6 – 50m ³ Masonry Sump				
BILL No. 7 - 100m ³ Tank				
BILL NO. 8 – Pump House				
BILL No.9 – Pumping Unit				
BILL No. 10 - Fencing - 200m perimeter				
Totals				
Add 10% Contingency				
TOTALS				

N/B

Section 82 of the Public Procurement and Asset Disposal Act 2015 states that “The tender sum as submitted and read out during the tender opening shall be absolute and final and shall not be the subject of correction, adjustment or amendment in any way by any person or entity” ANY SUBSTANTIAL ERRORS OF THE READ OUT BID SUM SHALL BE DECLARED A MAJOR DEVIATION, Bidders Must Ensure That Their Grand Totals transferred to the Form Of Tender Are Accurate

NOTES FOR PREPARING BILLS OF QUANTITIES

1.0 The objectives of the Bills of Quantities are;

- (a) to provide sufficient information on the quantities of Works to be performed to enable tenders to be prepared efficiently and accurately; and
- (b) when a Contract has been entered into, to provide a priced Bill of Quantities for use in the periodic valuation of Works executed.

In order to attain these objectives, Works are itemized in the Bill of Quantities in sufficient detail to distinguish between the different classes of Works, or between Works of the same nature carried out in different locations or in other circumstances which may give rise to different considerations of cost.

2.0 The Bills of Quantities are divided generally into the following sections:

(a) Preliminaries.

The preliminaries indicate the inclusiveness of the unit prices, and state the methods of measurement which have been adopted in the preparation of the Bill of Quantities and which are to be used for the measurement of any part of the Works.

The number of preliminary items to be priced by the tenderer is limited to tangible items such as site office and other temporary works, otherwise items such as security for the Works which are primarily part of the Contractor's obligations should be included in the Contractor's rates.

(b) Work Items

(i) The items in the Bills of Quantities should be grouped into sections to distinguish between those parts of the Works which by nature, location, access, timing, or any other special characteristics may give rise to different methods of construction, or phasing of the Works, or considerations of cost. General items common to all parts of the Works may be grouped as a separate section in the Bill of Quantities.

(ii) Quantities are computed net from the Drawings, and no allowance has been made for bulking, shrinkage or waste. Quantities have been rounded up or down where appropriate.

(iii) The following units of measurement and abbreviations are recommended for use.

Unit	Abbreviation
Cubic Meter	<i>m³</i>
Hectare	<i>Ha</i>
Hour	<i>Hr</i>
Kilogram	<i>Kg</i>
Lump Sum	<i>L.S.</i>
Meter	<i>M</i>
Metric Ton (1,000 Kg)	<i>Ton</i>
Millimeter	<i>Mm</i>
Month	<i>Mth</i>
Number	<i>No</i>
Square Meter	<i>m²</i>
Square Millimeter	<i>mm²</i>
Week	<i>Wk</i>

(c) Day work Schedule

A Day work Schedule has been included to take care of situations where the probability of unforeseen work, outside the items included in the Bill of Quantities, is relatively high.

(d) As- Built Drawings and operating and maintenance manuals

The Contractor is required to prepare As- built drawings and Operating and Maintenance manuals in the general conditions of contract clause 61.1 in section V of this bidding document. Clauses 135 and 137 of the technical specifications appearing in chapter 1 (General) require that the contractor prepares Operating and Maintenance manuals and As-built drawings. As-built drawings shall be prepared as work proceeds. The number of copies to be submitted with the original is also specified.

The rates provided by the Tenderers shall be deemed to include the preparation of Operating and Maintenance manuals and As-built drawings and no separate bill item has been included

PART III - CONDITIONS OF CONTRACT AND CONTRACT FORMS

Fairness, Transparency & Accountability

SECTION VIII - GENERAL CONDITIONS OF CONTRACT

These General Conditions of Contract (GCC), read in conjunction with the Special Conditions of Contract (SCC) and other documents listed therein, should be a complete document expressing fairly the rights and obligations of both parties.

These General Conditions of Contract have been developed on the basis of considerable international experience in the drafting and management of contracts, bearing in mind a trend in the construction industry towards simpler, more straightforward language.

The GCC can be used for both smaller admeasurement contracts and lump sum contracts.

General Conditions of Contract

A. General

1. Definitions

1.1 Bold face type is used to identify defined terms.

- a) **The Accepted Contract Amount** means the amount accepted in the Letter of Acceptance for the execution and completion of the Works and the remedying of any defects.
- b) **The Activity Schedule** is a schedule of the activities comprising the construction, installation, testing, and commissioning of the Works in a lump sum contract. It includes a lump sum price for each activity, which is used for valuations and for assessing the effects of Variations and Compensation Events.
- c) **The Adjudicator** is the person appointed jointly by the Procuring Entity and the Contractor to resolve disputes in the first instance, as provided for in GCC 23.
- d) **Bill of Quantities** means the priced and completed Bill of Quantities forming part of the Bid.
- e) **Compensation Events** are those defined in GCC Clause 42 hereunder.
- f) **The Completion Date** is the date of completion of the Works as certified by the Project Manager, in accordance with GCC Sub-Clause 53.1.
- g) **The Contract** is the Contract between the Procuring Entity and the Contractor to execute, complete, and maintain the Works. It consists of the documents listed in GCC Sub-Clause 2.3 below.
- h) **The Contractor** is the party whose Bid to carry out the Works has been accepted by the Procuring Entity.
- i) **The Contractor's Bid** is the completed bidding document submitted by the Contractor to the Procuring Entity.
- j) **The Contract Price** is the Accepted Contract Amount stated in the Letter of Acceptance and thereafter as adjusted in accordance with the Contract.
- k) **Days** are calendar days; months are calendar months.
- l) **Day works** are varied work inputs subject to payment on a time basis for the Contractor's employees and Equipment, in addition to payments for associated Materials and Plant.
- m) **A Defect** is any part of the Works not completed in accordance with the Contract.
- n) **The Defects Liability Certificate** is the certificate issued by Project Manager upon correction of defects by the Contractor.
- o) **The Defects Liability Period** is the period **named in the SCC** pursuant to Sub-Clause 34.1 and calculated from the Completion Date.

- p) **Drawings** means the drawings of the Works, as included in the Contract, and any additional and modified drawings issued by (or on behalf of) the Procuring Entity in accordance with the Contract, include calculations and other information provided or approved by the Project Manager for the execution of the Contract.
- q) **The Procuring Entity** is the party who employs the Contractor to carry out the Works, **as specified in the SCC**, who is also the Procuring Entity.
- r) **Equipment** is the Contractor's machinery and vehicles brought temporarily to the Site to construct the Works.
- s) **“In writing” or “written”** means hand-written, type-written, printed or electronically made, and resulting in a permanent record;
- t) The Initial Contract Price is the Contract Price listed in the Procuring Entity's Letter of Acceptance.
- u) **The Intended Completion Date** is the date on which it is intended that the Contractor shall complete the Works. The Intended Completion Date is **specified in the SCC**. The Intended Completion Date may be revised only by the Project Manager by issuing an extension of time or an acceleration order.
- v) **Materials** are all supplies, including consumables, used by the Contractor for incorporation in the Works.
- w) **Plant** is any integral part of the Works that shall have a mechanical, electrical, chemical, or biological function.
- x) **The Project Manager** is the person **named in the SCC** (or any other competent person appointed by the Procuring Entity and notified to the Contractor, to act in replacement of the Project Manager) who is responsible for supervising the execution of the Works and administering the Contract.
- y) **SCC** means Special Conditions of Contract.
- z) **The Site** is the area of the works as **defined as such in the SCC**.
- aa) **Site Investigation Reports** are those that were included in the bidding document and are factual and interpretative reports about the surface and subsurface conditions at the Site.
- bb) **Specification** means the Specification of the Works included in the Contract and any modification or addition made or approved by the Project Manager.
- cc) **The Start Date** is **given in the SCC**. It is the latest date when the Contractor shall commence execution of the Works. It does not necessarily coincide with any of the Site Possession Dates.
- dd) A **Subcontractor** is a person or corporate body who has a Contract with the Contractor to carry out a part of the work in the Contract, which includes work on the Site.
- ee) **Temporary Works** are works designed, constructed, installed, and removed by the Contractor that are needed for construction or installation of the Works.
- ff) A **Variation** is an instruction given by the Project Manager which varies the Works.
- gg) **The Works** are what the Contract requires the Contractor to construct, install, and turn over to the Procuring Entity, **as defined in the SCC**.

2. Interpretation

- 21 In interpreting these GCC, words indicating one gender include all genders. Words indicating the singular also include the plural and words indicating the plural also include the singular. Headings

have no significance. Words have their normal meaning under the language of the Contract unless specifically defined. The Project Manager shall provide instructions clarifying queries about these GCC.

- 22 If sectional completion is specified in the SCC, references in the GCC to the Works, the Completion Date, and the Intended Completion Date apply to any Section of the Works (other than references to the Completion Date and Intended Completion Date for the whole of the Works).
- 23 The documents forming the Contract shall be interpreted in the following order of priority:
 - a) Agreement,
 - b) Letter of Acceptance,
 - c) Contractor's Bid,
 - d) Special Conditions of Contract,
 - e) General Conditions of Contract, including Appendices,
 - f) Specifications,
 - g) Drawings,
 - h) Bill of Quantities⁶, and
 - i) any other document **listed in the SCC** as forming part of the Contract.

⁶In lump sum contracts, delete “Bill of Quantities” and replace with “Activity Schedule.”

3. Language and Law

- 31 The language of the Contract is English Language and the law governing the Contract are the Laws of Kenya.
- 32 Throughout the execution of the Contract, the Contractor shall comply with the import of goods and services prohibitions in the Procuring Entity's Country when
 - a) as a matter of law or official regulations, Kenya prohibits commercial relations with that country; or
 - b) by an act of compliance with a decision of the United Nations Security Council taken under Chapter VII of the Charter of the United Nations, Kenya prohibits any import of goods from that country or any payments to any country, person, or entity in that country.

4. Project Manager's Decisions

- 41 Except where otherwise specifically stated, the Project Manager shall decide contractual matters between the Procuring Entity and the Contractor in the role representing the Procuring Entity.

5. Delegation

- 51 Otherwise **specified in the SCC**, the Project Manager may delegate any of his duties and responsibilities to other people, except to the Adjudicator, after notifying the Contractor, and may revoke any delegation after notifying the Contractor.

6. Communications

- 61 Communications between parties that are referred to in the Conditions shall be effective only when in writing. A notice shall be effective only when it is delivered.

7. Subcontracting

- 7.1 The Contractor may subcontract with the approval of the Project Manager, but may not assign the Contract without the approval of the Procuring Entity in writing. Subcontracting shall not alter the Contractor's obligations.

8. Other Contractors

- 8.1 The Contractor shall cooperate and share the Site with other contractors, public authorities, utilities, and the Procuring Entity between the dates given in the Schedule of Other Contractors, as **referred to in the SCC**. The Contractor shall also provide facilities and services for them as described in the Schedule. The Procuring Entity may modify the Schedule of Other Contractors, and shall notify the Contractor of any such modification.

9. Personnel and Equipment

- 9.1 The Contractor shall employ the key personnel and use the equipment identified in its Bid, to carry out the Works or other personnel and equipment approved by the Project Manager. The Project Manager shall approve any proposed replacement of key personnel and equipment only if their relevant qualifications or characteristics are substantially equal to or better than those proposed in the Bid.
- 9.2 If the Project Manager asks the Contractor to remove a person who is a member of the Contractor's staff or work force, stating the reasons, the Contractor shall ensure that the person leaves the Site within seven days and has no further connection with the work in the Contract.
- 9.3 If the Procuring Entity, Project Manager or Contractor determines, that any employee of the Contractor be determined to have engaged in Fraud and Corruption during the execution of the Works, then that employee shall be removed in accordance with Clause 9.2 above.

10. Procuring Entity's and Contractor's Risks

- 10.1 The Procuring Entity carries the risks which this Contract states are Procuring Entity's risks, and the Contractor carries the risks which this Contract states are Contractor's risks.

11. Procuring Entity's Risks

- 11.1 From the Start Date until the Defects Liability Certificate has been issued, the following are Procuring Entity's risks:

- a) The risk of personal injury, death, or loss of or damage to property (excluding the Works, Plant, Materials, and Equipment), which are due to
 - i) use or occupation of the Site by the Works or for the purpose of the Works, which is the unavoidable result of the Works or
 - ii) negligence, breach of statutory duty, or interference with any legal right by the Procuring Entity or by any person employed by or contracted to him except the Contractor.

- b) The risk of damage to the Works, Plant, Materials, and Equipment to the extent that it is due to a fault of the Procuring Entity or in the Procuring Entity's design, or due to war or radioactive contamination directly affecting the country where the Works are to be executed.

- 11.2 From the Completion Date until the Defects Liability Certificate has been issued, the risk of loss of or damage to the Works, Plant, and Materials is a Procuring Entity's risk except loss or damage due to

- aa) a Defect which existed on the Completion Date,
- bb) an event occurring before the Completion Date, which was not itself a Procuring Entity's risk, or

cc) the activities of the Contractor on the Site after the Completion Date.

12. Contractor's Risks

121 From the Starting Date until the Defects Liability Certificate has been issued, the risks of personal injury, death, and loss of or damage to property (including, without limitation, the Works, Plant, Materials, and Equipment) which are not Procuring Entity's risks are Contractor's risks.

13. Insurance

131 The Contractor shall provide, in the joint names of the Procuring Entity and the Contractor, insurance cover from the Start Date to the end of the Defects Liability Period, in the amounts and deductibles **stated in the SCC** for the following events which are due to the Contractor's risks:

- a) loss of or damage to the Works, Plant, and Materials;
- b) loss of or damage to Equipment;
- c) loss of or damage to property (except the Works, Plant, Materials, and Equipment) in connection with the Contract; and
- d) personal injury or death.

132 Policies and certificates for insurance shall be delivered by the Contractor to the Project Manager for the Project Manager's approval before the Start Date. All such insurance shall provide for compensation to be payable in the types and proportions of currencies required to rectify the loss or damage incurred.

133 If the Contractor does not provide any of the policies and certificates required, the Procuring Entity may affect the insurance which the Contractor should have provided and recover the premiums the Procuring Entity has paid from payments otherwise due to the Contractor or, if no payment is due, the payment of the premiums shall be a debt due.

134 Alterations to the terms of an insurance shall not be made without the approval of the Project Manager.

135 Both parties shall comply with any conditions of the insurance policies.

14. Site Data

141 The Contractor shall be deemed to have examined any Site Data **referred to in the SCC**, supplemented by any information available to the Contractor.

15. Contractor to Construct the Works

151 The Contractor shall construct and install the Works in accordance with the Specifications and Drawings.

16. The Works to Be Completed by the Intended Completion Date

161 The Contractor may commence execution of the Works on the Start Date and shall carry out the Works in accordance with the Program submitted by the Contractor, as updated with the approval of the Project Manager, and complete them by the Intended Completion Date.

17. Approval by the Project Manager

171 The Contractor shall submit Specifications and Drawings showing the proposed Temporary Works to the Project Manager, for his approval.

172 The Contractor shall be responsible for design of Temporary Works.

173 The Project Manager's approval shall not alter the Contractor's responsibility for design of the Temporary Works.

174 The Contractor shall obtain approval of third parties to the design of the Temporary Works, where required.

175 All Drawings prepared by the Contractor for the execution of the temporary or permanent Works, are subject to prior approval by the Project Manager before this use.

18. Safety

181 The Contractor shall be responsible for the safety of all activities on the Site.

19. Discoveries

191 Anything of historical or other interest or of significant value unexpectedly discovered on the Site shall be the property of the Procuring Entity. The Contractor shall notify the Project Manager of such discoveries and carry out the Project Manager's instructions for dealing with them.

20. Possession of the Site

201 The Procuring Entity shall give possession of all parts of the Site to the Contractor. If possession of a part is not given by the date **stated in the SCC**, the Procuring Entity shall be deemed to have delayed the start of the relevant activities, and this shall be a Compensation Event.

21. Access to the Site

211 The Contractor shall allow the Project Manager and any person authorized by the Project Manager access to the Site and to any place where work in connection with the Contract is being carried out or is intended to be carried out.

22. Instructions, Inspections and Audits

221 The Contractor shall carry out all instructions of the Project Manager which comply with the applicable laws where the Site is located.

222 The Contractor shall keep, and shall make all reasonable efforts to cause its Subcontractors and sub-consultants to keep, accurate and systematic accounts and records in respect of the Works in such form and details as will clearly identify relevant time changes and costs.

223 The Contractor shall permit and shall cause its subcontractors and sub-consultants to permit, the Procuring Entity and/or persons appointed by the Public Procurement Regulatory Authority to inspect the Site and/or the accounts and records relating to the procurement process, selection and/or contract execution, and to have such accounts and records audited by auditors appointed by the Public Procurement Regulatory Authority. The Contractor's and its Subcontractors' and sub-consultants' attention is drawn to Sub- Clause 25.1 (Fraud and Corruption) which provides, inter alia, that acts intended to materially impede the exercise of the Public Procurement Regulatory Authority's inspection and audit rights constitute a prohibited practice subject to contract termination (as well as to a determination of ineligibility pursuant to the Public Procurement Regulatory Authority's prevailing sanctions procedures).

23. Appointment of the Adjudicator

231 The Adjudicator shall be appointed jointly by the Procuring Entity and the Contractor, at the time of the Procuring Entity's issuance of the Letter of Acceptance. If, in the Letter of Acceptance, the Procuring Entity does not agree on the appointment of the Adjudicator, the Procuring Entity will request the Appointing Authority designated in the SCC, to appoint the Adjudicator within 14 days of receipt of such request.

232 Should the Adjudicator resign or die, or should the Procuring Entity and the Contractor agree that

the Adjudicator is not functioning in accordance with the provisions of the Contract, a new Adjudicator shall be jointly appointed by the Procuring Entity and the Contractor. In case of disagreement between the Procuring Entity and the Contractor, within 30 days, the Adjudicator shall be designated by the Appointing Authority designated in the SCC at the request of either party, within 14 days of receipt of such request.

24. Settlement of Claims and Disputes

241 Contractor's Claims

24.1.1 If the Contractor considers itself to be entitled to any extension of the Time for Completion and/or any additional payment, under any Clause of these Conditions or otherwise in connection with the Contract, the Contractor shall give Notice to the Project Manager, describing the event or circumstance giving rise to the claim. The notice shall be given as soon as practicable, and not later than 30 days after the Contractor became aware, or should have become aware, of the event or circumstance.

24.1.2 If the Contractor fails to give notice of a claim within such period of 30 days, the Time for Completion shall not be extended, the Contractor shall not be entitled to additional payment, and the Procuring Entity shall be discharged from all liability in connection with the claim. Otherwise, the following provisions of this Sub- Clause shall apply.

24.1.3 The Contractor shall also submit any other notices which are required by the Contract, and supporting particulars for the claim, all as relevant to such event or circumstance.

24.1.4 The Contractor shall keep such contemporary records as may be necessary to substantiate any claim, either on the Site or at another location acceptable to the Project Manager. Without admitting the Procuring Entity's liability, the Project Manager may, after receiving any notice under this Sub-Clause, monitor the record- keeping and/or instruct the Contractor to keep further contemporary records. The Contractor shall permit the Project Manager to inspect all these records, and shall (if instructed) submit copies to the Project Manager.

24.1.5 Within 42 days after the Contractor became aware (or should have become aware) of the event or circumstance giving rise to the claim, or within such other period as may be proposed by the Contractor and approved by the Project Manager, the Contractor shall send to the Project Manager a fully detailed claim which includes full supporting particulars of the basis of the claim and of the extension of time and/or additional payment claimed. If the event or circumstance giving rise to the claim has a continuing effect:

- a) this fully detailed claim shall be considered as interim;
- b) the Contractor shall send further interim claims at monthly intervals, giving the accumulated delay and/or amount claimed, and such further particulars as the Project Manager may reasonably require; and
- c) the Contractor shall send a final claim within 30 days after the end of the effects resulting from the event or circumstance, or within such other period as may be proposed by the Contractor and approved by the Project Manager.

24.1.6 Within 42 days after receiving a Notice of a claim or any further particulars supporting a previous claim, or within such other period as may be proposed by the Project Manager and approved by the Contractor, the Project Manager shall respond with approval, or with disapproval and detailed comments. He may also request any necessary further particulars, but shall nevertheless give his response on the principles of the claim within the above defined time period.

24.1.7 Within the above defined period of 42 days, the Project Manager shall proceed in accordance

24.1.8 [Determinations] to agree or determine (i) the extension (if any) of the Time for Completion (before or after its expiry) in accordance with Sub-Clause 8.4 [Extension of Time for Completion], and/or (ii) the additional payment (if any) to which the Contractor is entitled under the Contract.

24.1.9 Each Payment Certificate shall include such additional payment for any claim as has been reasonably substantiated as due under the relevant provision of the Contract. Unless and until the particulars supplied are sufficient to substantiate the whole of the claim, the Contractor shall only be entitled to payment for such part of the claim as he has been able to substantiate.

24.1.10 If the Project Manager does not respond within the timeframe defined in this Clause, either Party may consider that the claim is rejected by the Project Manager and any of the Parties may refer to Arbitration in accordance with Sub-Clause 24.4 [Arbitration].

24.1.11 The requirements of this Sub-Clause are in addition to those of any other Sub-Clause which may apply to a claim. If the Contractor fails to comply with this or another Sub-Clause in relation to any claim, any extension of time and/or additional payment shall take account of the extent (if any) to which the failure has prevented or prejudiced proper investigation of the claim, unless the claim is excluded under the second paragraph of this Sub-Clause 24.3.

242 Amicable Settlement

24.2.1 Where a notice of a claim has been given, both Parties shall attempt to settle the dispute amicably before the commencement of arbitration. However, unless both Parties agree otherwise, the Party giving a notice of a claim in accordance with Sub-Clause 24.1 above should move to commence arbitration after the fifty-sixth day from the day on which a notice of a claim was given, even if no attempt at an amicable settlement has been made.

243 Matters that may be referred to arbitration

24.3.1 Notwithstanding anything stated herein the following matters may be referred to arbitration before the practical completion of the Works or abandonment of the Works or termination of the Contract by either party:

- a) The appointment of a replacement Project Manager upon the said person ceasing to act.
- b) Whether or not the issue of an instruction by the Project Manager is empowered by these Conditions.
- c) Whether or not a certificate has been improperly withheld or is not in accordance with these Conditions.
- e) Any dispute arising in respect of war risks or war damage.
- f) All other matters shall only be referred to arbitration after the completion or alleged completion of the Works or termination or alleged termination of the Contract, unless the Procuring Entity and the Contractor agree otherwise in writing.

244 Arbitration

24.4.1 Any claim or dispute between the Parties arising out of or in connection with the Contract not settled amicably in accordance with Sub-Clause 24.3 shall be finally settled by arbitration.

24.4.2 No arbitration proceedings shall be commenced on any claim or dispute where notice of a claim or dispute has not been given by the applying party within ninety days of the occurrence or discovery of the matter or issue giving rise to the dispute.

24.4.3 Notwithstanding the issue of a notice as stated above, the arbitration of such a claim or dispute shall not commence unless an attempt has in the first instance been made by the parties to settle such claim or dispute amicably with or without the assistance of third parties. Proof of such attempt shall be required.

- 24.4.4 The Arbitrator shall, without prejudice to the generality of his powers, have powers to direct such measurements, computations, tests or valuations as may in his opinion be desirable in order to determine the rights of the parties and assess and award any sums which ought to have been the subject of or included in any certificate.
- 24.4.5 The Arbitrator shall, without prejudice to the generality of his powers, have powers to open up, review and revise any certificate, opinion, decision, requirement or notice and to determine all matters in dispute which shall be submitted to him in the same manner as if no such certificate, opinion, decision requirement or notice had been given.
- 24.4.6 The arbitrators shall have full power to open up, review and revise any certificate, determination, instruction, opinion or valuation of the Project Manager, relevant to the dispute. Nothing shall disqualify representatives of the Parties and the Project Manager from being called as a witness and giving evidence before the arbitrators on any matter whatsoever relevant to the dispute.
- 24.4.7 Neither Party shall be limited in the proceedings before the arbitrators to the evidence, or to the reasons for dissatisfaction given in its Notice of Dissatisfaction.
- 24.4.8 Arbitration may be commenced prior to or after completion of the Works. The obligations of the Parties, and the Project Manager shall not be altered by reason of any arbitration being conducted during the progress of the Works.
- 24.4.9 The terms of the remuneration of each or all the members of Arbitration shall be mutually agreed upon by the Parties when agreeing the terms of appointment. Each Party shall be responsible for paying one-half of this remuneration.

245 Arbitration with National Contractors

- 24.5.1 If the Contract is with national contractors, arbitration proceedings will be conducted in accordance with the Arbitration Laws of Kenya. In case of any claim or dispute, such claim or dispute shall be notified in writing by either party to the other with a request to submit it to arbitration and to concur in the appointment of an Arbitrator within thirty days of the notice. The dispute shall be referred to the arbitration and final decision of a person to be agreed between the parties. Failing agreement to concur in the appointment of an Arbitrator, the Arbitrator shall be appointed, on the request of the applying party, by the Chairman or Vice Chairman of any of the following professional institutions;
- i) Architectural Association of Kenya
 - ii) Institute of Quantity Surveyors of Kenya
 - iii) Association of Consulting Engineers of Kenya
 - iv) Chartered Institute of Arbitrators (Kenya Branch)
 - v) Institution of Engineers of Kenya
- 24.5.2 The institution written to first by the aggrieved party shall take precedence over all other institutions.

246 Alternative Arbitration Proceedings

- 24.6.1 Alternatively, the Parties may refer the matter to the Nairobi Centre for International Arbitration (NCIA) which offers a neutral venue for the conduct of national and international arbitration with commitment to providing institutional support to the arbitral process.

247 Failure to Comply with Arbitrator's Decision

- 24.7.1 The award of such Arbitrator shall be final and binding upon the parties.
- 24.7.2 In the event that a Party fails to comply with a final and binding Arbitrator's decision, then the other Party may, without prejudice to any other rights it may have, refer the matter to a competent court of law.

248 Contract operations to continue

- 24.8.1 Notwithstanding any reference to arbitration herein,
- a) the parties shall continue to perform their respective obligations under the Contract unless they otherwise agree; and
 - b) the Procuring Entity shall pay the Contractor any monies due the Contractor.

25. Fraud and Corruption

- 25.1 The Government requires compliance with the country's Anti-Corruption laws and its prevailing sanctions policies and procedures as set forth in the Constitution of Kenya and its Statutes.
- 25.2 The Procuring Entity requires the Contractor to disclose any commissions or fees that may have been paid or are to be paid to agents or any other party with respect to the bidding process or execution of the Contract. The information disclosed must include at least the name and address of the agent or other party, the amount and currency, and the purpose of the commission, gratuity or fee.

B. Time Control

26. Program

- 26.1 Within the time stated in the SCC, after the date of the Letter of Acceptance, the Contractor shall submit to the Project Manager for approval a Program showing the general methods, arrangements, order, and timing for all the activities in the Works. In the case of a lump sum contract, the activities in the Program shall be consistent with those in the Activity Schedule.
- 26.2 An update of the Program shall be a program showing the actual progress achieved on each activity and the effect of the progress achieved on the timing of the remaining work, including any changes to the sequence of the activities.
- 26.3 The Contractor shall submit to the Project Manager for approval an updated Program at intervals no longer than the period stated in the SCC. If the Contractor does not submit an updated Program within this period, the Project Manager may withhold the amount stated in the SCC from the next payment certificate and continue to withhold this amount until the next payment after the date on which the overdue Program has been submitted. In the case of a lump sum contract, the Contractor shall provide an updated Activity Schedule within 14 days of being instructed to by the Project Manager.
- 26.4 The Project Manager's approval of the Program shall not alter the Contractor's obligations. The Contractor may revise the Program and submit it to the Project Manager again at any time. A revised Program shall show the effect of Variations and Compensation Events.

27. Extension of the Intended Completion Date

- 27.1 The Project Manager shall extend the Intended Completion Date if a Compensation Event occurs or a Variation is issued which makes it impossible for Completion to be achieved by the Intended Completion Date without the Contractor taking steps to accelerate the remaining work, which would cause the Contractor to incur additional cost.
- 27.2 The Project Manager shall decide whether and by how much to extend the Intended Completion Date within 21 days of the Contractor asking the Project Manager for a decision upon the effect of a Compensation Event or Variation and submitting full supporting information. If the Contractor has failed to give early warning of a delay or has failed to cooperate in dealing with a delay, the delay by this failure shall not be considered in assessing the new Intended Completion Date.

28. Acceleration

- 28.1 When the Procuring Entity wants the Contractor to finish before the Intended Completion Date, the Project Manager shall obtain priced proposals for achieving the necessary acceleration from the Contractor. If the Procuring Entity accepts these proposals, the Intended Completion Date shall be adjusted accordingly and confirmed by both the Procuring Entity and the Contractor.
- 28.2 If the Contractor's priced proposals for an acceleration are accepted by the Procuring Entity, they are incorporated in the Contract Price and treated as a Variation.

29. Delays Ordered by the Project Manager

29.1 The Project Manager may instruct the Contractor to delay the start or progress of any activity within the Works.

30. Management Meetings

30.1 Either the Project Manager or the Contractor may require the other to attend a management meeting. The business of a management meeting shall be to review the plans for remaining work and to deal with matters raised in accordance with the early warning procedure.

30.2 The Project Manager shall record the business of management meetings and provide copies of the record to those attending the meeting and to the Procuring Entity. The responsibility of the parties for actions to be taken shall be decided by the Project Manager either at the management meeting or after the management meeting and stated in writing to all who attended the meeting.

31. Early Warning

31.1 The Contractor shall warn the Project Manager at the earliest opportunity of specific likely future events or circumstances that may adversely affect the quality of the work, increase the Contract Price, or delay the execution of the Works. The Project Manager may require the Contractor to provide an estimate of the expected effect of the future event or circumstance on the Contract Price and Completion Date. The estimate shall be provided by the Contractor as soon as reasonably possible.

31.2 The Contractor shall cooperate with the Project Manager in making and considering proposals for how the effect of such an event or circumstance can be avoided or reduced by anyone involved in the work and in carrying out any resulting instruction of the Project Manager.

C. Quality Control

32. Identifying Defects

32.1 The Project Manager shall check the Contractor's work and notify the Contractor of any Defects that are found. Such checking shall not affect the Contractor's responsibilities. The Project Manager may instruct the Contractor to search for a Defect and to uncover and test any work that the Project Manager considers may have a Defect.

33. Tests

33.1 If the Project Manager instructs the Contractor to carry out a test not specified in the Specification to check whether any work has a Defect and the test shows that it does, the Contractor shall pay for the test and any samples. If there is no Defect, the test shall be a Compensation Event.

34. Correction of Defects

34.1 The Project Manager shall give notice to the Contractor of any Defects before the end of the Defects Liability Period, which begins at Completion, and is defined in the SCC. The Defects Liability Period shall be extended for as long as Defects remain to be corrected.

34.2 Every time notice of a Defect is given, the Contractor shall correct the notified Defect within the length of time specified by the Project Manager's notice.

35. Uncorrected Defects

35.1 If the Contractor has not corrected a Defect within the time specified in the Project Manager's notice, the Project Manager shall assess the cost of having the Defect corrected, and the Contractor shall pay this amount.

D. Cost Control

36.1 The Bill of Quantities shall contain priced items for the Works to be performed by the Contractor. The Bill of Quantities is used to calculate the Contract Price. The Contractor will be paid for the quantity of the work accomplished at the rate in the Bill of Quantities for each item.

37. Changes in the Contract Price⁸

37.1 If the final quantity of the work done differs from the quantity in the Bill of Quantities for the particular item by more than 25 percent, provided the change exceeds 1 percent of the Initial Contract Price, the Project Manager shall adjust the rate to allow for the change. The Project Manager shall not adjust rates from changes in quantities if thereby the Initial Contract Price is exceeded by more than 15 percent, except with the prior approval of the Procuring Entity.

37.2 If requested by the Project Manager, the Contractor shall provide the Project Manager with a detailed cost breakdown of any rate in the Bill of Quantities.

38. Variations

38.1 All Variations shall be included in updated Programs⁹ produced by the Contractor.

38.2 The Contractor shall provide the Project Manager with a quotation for carrying out the Variation when requested to do so by the Project Manager. The Project Manager shall assess the quotation, which shall be given within seven (7) days of the request or within any longer period stated by the Project Manager and before the Variation is ordered.

38.3 If the Contractor's quotation is unreasonable, the Project Manager may order the Variation and make a change to the Contract Price, which shall be based on the Project Manager's own forecast of the effects of the Variation on the Contractor's costs.

38.4 If the Project Manager decides that the urgency of varying the work would prevent a quotation being given and considered without delaying the work, no quotation shall be

given and the Variation shall be treated as a Compensation Event.

38.5 The Contractor shall not be entitled to additional payment for costs that could have been avoided by giving early warning

38.6 If the work in the Variation corresponds to an item description in the Bill of Quantities and if, in the opinion of the Project Manager, the quantity of work above the limit stated in Sub-Clause 39.1 or the timing of its execution do not cause the cost per unit of quantity to change, the rate in the Bill of Quantities shall be used to calculate the value of the Variation. If the cost per unit of quantity changes, or if the nature or timing of the work in the Variation does not correspond with items in the Bill of Quantities, the quotation by the Contractor shall be in the form of new rates for the relevant items of work

38.7 Value Engineering: The Contractor may prepare, at its own cost, a value engineering proposal at any time during the performance of the contract. The value engineering proposal shall, at a minimum, include the following;

- a) the proposed change(s), and a description of the difference to the existing contract requirements;
- b) a full cost/benefit analysis of the proposed change(s) including a description and estimate of costs (including life cycle costs) the Procuring Entity may incur in implementing the value engineering proposal; and
- c) a description of any effect(s) of the change on performance/functionality.

388 The Procuring Entity may accept the value engineering proposal if the proposal demonstrates benefits that:

- a) accelerate the contract completion period; or
- b) reduce the Contract Price or the life cycle costs to the Procuring Entity; or
- c) improve the quality, efficiency, safety or sustainability of the Facilities; or
- d) yield any other benefits to the Procuring Entity, without compromising the functionality of the Works.

389 If the value engineering proposal is approved by the Procuring Entity and results in:

- a) a reduction of the Contract Price; the amount to be paid to the Contractor shall be the **percentage specified in the SCC** of the reduction in the Contract Price; or
- b) an increase in the Contract Price; but results in a reduction in life cycle costs due to any benefit described in
(a) to (d) above, the amount to be paid to the Contractor shall be the full increase in the Contract Price.

39. Cash Flow Forecasts

39.1 When the Program¹¹, is updated, the Contractor shall provide the Project Manager with an updated cash flow forecast. The cash flow forecast shall include different currencies, as defined in the Contract, converted as necessary using the Contract exchange rates.

40. Payment Certificates

40.1 The Contractor shall submit to the Project Manager monthly statements of the estimated value of the work executed less the cumulative amount certified previously.

40.2 The Project Manager shall check the Contractor's monthly statement and certify the amount to be paid to the Contractor.

40.3 The value of work executed shall be determined by the Project Manager.

40.4 The value of work executed shall comprise the value of the quantities of work in the Bill of Quantities that have been completed¹².

40.5 The value of work executed shall include the valuation of Variations and Compensation Events.

40.6 The Project Manager may exclude any item certified in a previous certificate or reduce the proportion of any item previously certified in any certificate in the light of later information.

40.7 Where the contract price is different from the corrected tender price, in order to ensure the contractor is not paid less or more relative to the contract price (which would be the tender price), payment valuation certificates and variation orders on omissions and additions valued based on rates in the Bill of Quantities or schedule of rates in the Tender, will be adjusted by a plus or minus percentage. The percentage already worked out during tender evaluation is worked out as follows: $(\text{corrected tender price} - \text{tender price}) / \text{tender price} \times 100$.

41. Payments

41.1 Payments shall be adjusted for deductions for advance payments and retention. The Procuring Entity shall pay the Contractor the amounts certified by the Project Manager within 30 days of the date of each certificate. If the Procuring Entity makes a late payment, the Contractor shall be paid interest on the late payment in the next payment. Interest shall be calculated from the date by which the payment should have been made up to the date when the late payment is made at the prevailing rate of interest for commercial borrowing for each of the currencies in which payments are made.

412 If an amount certified is increased in a later certificate or as a result of an award by the Adjudicator or an Arbitrator, the Contractor shall be paid interest upon the delayed payment as set out in this clause. Interest shall be calculated from the date upon which the increased amount would have been certified in the absence of dispute.

413 Unless otherwise stated, all payments and deductions shall be paid or charged in the proportions of currencies comprising the Contract Price.

414 Items of the Works for which no rate or price has been entered in shall not be paid for by the Procuring Entity and shall be deemed covered by other rates and prices in the Contract.

42. Compensation Events

421 The following shall be Compensation Events:

- d) The Procuring Entity does not give access to a part of the Site by the Site Possession Date pursuant to GCC Sub-Clause 20.1.
- e) The Procuring Entity modifies the Schedule of Other Contractors in a way that affects the work of the Contractor under the Contract.
- f) The Project Manager orders a delay or does not issue Drawings, Specifications, or instructions required for execution of the Works on time.
- g) The Project Manager instructs the Contractor to uncover or to carry out additional tests upon work, which is then found to have no Defects.
- h) The Project Manager unreasonably does not approve a subcontract to be let.
- i) Ground conditions are substantially more adverse than could reasonably have been assumed before issuance of the Letter of Acceptance from the information issued to bidders (including the Site Investigation Reports), from information available publicly and from a visual inspection of the Site.
- j) The Project Manager gives an instruction for dealing with an unforeseen condition, caused by the Procuring Entity, or additional work required for safety or other reasons.
- k) Other contractors, public authorities, utilities, or the Procuring Entity does not work within the dates and other constraints stated in the Contract, and they cause delay or extra cost to the Contractor.
- l) The advance payment is delayed.
- m) The effects on the Contractor of any of the Procuring Entity's Risks.
- n) The Project Manager unreasonably delays issuing a Certificate of Completion.

422 If a Compensation Event would cause additional cost or would prevent the work being completed before the Intended Completion Date, the Contract Price shall be increased and/or the Intended Completion Date shall be extended. The Project Manager shall decide whether and by how much the Contract Price shall be increased and whether and by how much the Intended Completion Date shall be extended.

423 As soon as information demonstrating the effect of each Compensation Event upon the Contractor's forecast cost has been provided by the Contractor, it shall be assessed by the Project Manager, and the Contract Price shall be adjusted accordingly. If the Contractor's forecast is deemed unreasonable, the Project Manager shall adjust the Contract Price based on the Project Manager's own forecast. The Project Manager shall assume that the

424 The Contractor shall not be entitled to compensation to the extent that the Procuring Entity's interests are adversely affected by the Contractor's not having given early warning or not having cooperated

43. Tax

43.1 The Project Manager shall adjust the Contract Price if taxes, duties, and other levies are changed between the date 30 days before the submission of bids for the Contract and the date of the last Completion certificate. The adjustment shall be the change in the amount of tax payable by the Contractor, provided such changes are not already reflected in the Contract Price or are a result of GCC Clause 44.

44. Currency of Payment

44.1 All payments under the contract shall be made in Kenya Shillings

45. Price Adjustment

45.1 Prices shall be adjusted for fluctuations in the cost of inputs only if **provided for in the SCC**. If so provided, the amounts certified in each payment certificate, before deducting for Advance Payment, shall be adjusted by applying the respective price adjustment factor to the payment amounts due in each currency. A separate formula of the type specified below applies:

$$P = A + B I_m/I_o$$

where:

the portion of the Contract Price payable.

P is the adjustment factor for

A and B are coefficients¹³ **specified in the SCC**, representing the non-adjustable and adjustable portions, respectively, of the Contract Price payable and I_m is the index prevailing at the end of the month being invoiced and I_o is the index prevailing 30 days before Bid opening for inputs payable.

45.2 If the value of the index is changed after it has been used in a calculation, the calculation shall be corrected and an adjustment made in the next payment certificate. The index value shall be deemed to take account of all changes in cost due to fluctuations in costs.

46. Retention

46.1 The Procuring Entity shall retain from each payment due to the Contractor the proportion stated in the SCC until Completion of the whole of the Works.

46.2 Upon the issue of a Certificate of Completion of the Works by the Project Manager, in accordance with GCC 53.1, half the total amount retained shall be repaid to the Contractor and half when the Defects Liability Period has passed and the Project Manager has certified that all Defects notified by the Project Manager to the Contractor before the end of this period have been corrected. The Contractor may substitute retention money with an "on demand" Bank guarantee.

47. Liquidated Damages

47.1 The Contractor shall pay liquidated damages to the Procuring Entity at the rate per day stated in the SCC for each day that the Completion Date is later than the Intended Completion Date. The total amount of liquidated damages shall not exceed the amount defined in the SCC. The Procuring Entity may deduct liquidated damages from payments due to the Contractor. Payment of liquidated damages shall not affect the Contractor's liabilities.

47.2 If the Intended Completion Date is extended after liquidated damages have been paid, the Project Manager shall correct any overpayment of liquidated damages by the Contractor by adjusting the next payment certificate. The Contractor shall be paid interest on the overpayment, calculated from the date of payment to the date of repayment, at the rates specified in GCC Sub-Clause 41.1.

48. Bonus

48.1 The Contractor shall be paid a Bonus calculated at the rate per calendar day **stated in the SCC** for

each day (less any days for which the Contractor is paid for acceleration) that the Completion is earlier than the Intended Completion Date. The Project Manager shall certify that the Works are complete, although they may not be due to be complete.

49. Advance Payment

- 49.1 The Procuring Entity shall make advance payment to the Contractor of the amounts stated in the SCC by the date stated in the SCC, against provision by the Contractor of an Unconditional Bank Guarantee in a form and by a bank acceptable to the Procuring Entity in amounts and currencies equal to the advance payment. The Guarantee shall remain effective until the advance payment has been repaid, but the amount of the Guarantee shall be progressively reduced by the amounts repaid by the Contractor. Interest shall not be charged on the advance payment.
- 49.2 The Contractor is to use the advance payment only to pay for Equipment, Plant, Materials, and mobilization expenses required specifically for execution of the Contract. The Contractor shall demonstrate that advance payment has been used in this way by supplying copies of invoices or other documents to the Project Manager.
- 49.3 The advance payment shall be repaid by deducting proportionate amounts from payments otherwise due to the Contractor, following the schedule of completed percentages of the Works on a payment basis. No account shall be taken of the advance payment or its repayment in assessing valuations of work done, Variations, price adjustments, Compensation Events, Bonuses, or Liquidated Damages.

50. Securities

- 50.1 The Performance Security shall be provided to the Procuring Entity no later than the date specified in the Letter of Acceptance and shall be issued in an amount **specified in the SCC**, by a bank or surety acceptable to the Procuring Entity, and denominated in the types and proportions of the currencies in which the Contract Price is payable. The Performance Security shall be valid until a date 28 day from the date of issue of the Certificate of Completion in the case of a Bank Guarantee, and until one year from the date of issue of the Completion Certificate in the case of a Performance Bond.

51. Dayworks

- 51.1 If applicable, the Dayworks rates in the Contractor's Bid shall be used only when the Project Manager has given written instructions in advance for additional work to be paid for in that way.
- 51.2 All work to be paid for as Dayworks shall be recorded by the Contractor on forms approved by the Project Manager. Each completed form shall be verified and signed by the Project Manager within two days of the work being done.
- 51.3 The Contractor shall be paid for Dayworks subject to obtaining signed Dayworks forms.

52. Cost of Repairs

- 52.1 Loss or damage to the Works or Materials to be incorporated in the Works between the Start Date and the end of the Defects Correction periods shall be remedied by the Contractor at the Contractor's cost if the loss or damage arises from the Contractor's acts or omissions.

E. Finishing the Contract

53. Completion

- 53.1 The Contractor shall request the Project Manager to issue a Certificate of Completion of the Works, and the Project Manager shall do so upon deciding that the whole of the Works is completed.

54. Taking Over

- 54.1 The Procuring Entity shall take over the Site and the Works within seven days of the Project Manager's issuing a certificate of Completion.

55. Final Account

55.1 The Contractor shall supply the Project Manager with a detailed account of the total amount that the Contractor considers payable under the Contract before the end of the Defects Liability Period. The Project Manager shall issue a Defects Liability Certificate and certify any final payment that is due to the Contractor within 56 days of receiving the Contractor's account if it is correct and complete. If it is not, the Project Manager shall issue within 56 days a schedule that states the scope of the corrections or additions that are necessary. If the Final Account is still unsatisfactory after it has been resubmitted, the Project Manager shall decide on the amount payable to the Contractor and issue a payment certificate.

56. Operating and Maintenance Manuals

56.1 If "as built" Drawings and/or operating and maintenance manuals are required, the Contractor shall supply them by the dates stated in the SCC.

56.2 If the Contractor does not supply the Drawings and/or manuals by the dates stated in the SCC pursuant to GCC Sub-Clause 56.1, or they do not receive the Project Manager's approval, the Project Manager shall withhold the amount **stated in the SCC** from payments due to the Contractor.

57. Termination

57.1 The Procuring Entity or the Contractor may terminate the Contract if the other party causes a fundamental breach of the Contract.

57.2 Fundamental breaches of Contract shall include, but shall not be limited to, the following:

- a) the Contractor stops work for 30 days when no stoppage of work is shown on the current Program and the stoppage has not been authorized by the Project Manager;
- b) the Project Manager instructs the Contractor to delay the progress of the Works, and the instruction is not withdrawn within 30 days;
- c) the Procuring Entity or the Contractor is made bankrupt or goes into liquidation other than for a reconstruction or amalgamation;
- d) a payment certified by the Project Manager is not paid by the Procuring Entity to the Contractor within 84 days of the date of the Project Manager's certificate;
- e) the Project Manager gives Notice that failure to correct a particular Defect is a fundamental breach of Contract and the Contractor fails to correct it within a reasonable period of time determined by the Project Manager;
- f) the Contractor does not maintain a Security, which is required;
- g) the Contractor has delayed the completion of the Works by the number of days for which the maximum amount of liquidated damages can be paid, as **defined in the SCC**; or
- h) if the Contractor, in the judgment of the Procuring Entity has engaged in Fraud and Corruption, as defined in paragraph 2.2 a of the Appendix A to the GCC, in competing for or in executing the Contract, then the Procuring Entity may, after giving fourteen (14) days written notice to the Contractor, terminate the Contract and expel him from the Site.

57.3 Notwithstanding the above, the Procuring Entity may terminate the Contract for convenience.

57.4 If the Contract is terminated, the Contractor shall stop work immediately, make the Site safe and secure, and leave the Site as soon as reasonably possible.

57.5 When either party to the Contract gives notice of a breach of Contract to the Project Manager for a cause other than those listed under GCC Sub-Clause 56.2 above, the Project Manager shall decide

58. Payment upon Termination

58.1 If the Contract is terminated because of a fundamental breach of Contract by the Contractor, the Project Manager shall issue a certificate for the value of the work done and Materials ordered less advance payments received up to the date of the issue of the certificate and less the percentage to apply to the value of the work not completed, as specified in the SCC. Additional Liquidated Damages shall not apply. If the total amount due to the Procuring Entity exceeds any payment due to the Contractor, the difference shall be a debt payable to the Procuring Entity.

58.2 If the Contract is terminated for the Procuring Entity's convenience or because of a fundamental breach of Contract by the Procuring Entity, the Project Manager shall issue a certificate for the value of the work done, Materials ordered, the reasonable cost of removal of Equipment, repatriation of the Contractor's personnel employed solely on the Works, and the Contractor's costs of protecting and securing the Works, and less advance payments received up to the date of the certificate.

59. Property

59.1 All Materials on the Site, Plant, Equipment, Temporary Works, and Works shall be deemed to be the property of the Procuring Entity if the Contract is terminated because of the Contractor's default.

60. Release from Performance

60.1 If the Contract is frustrated by the outbreak of war or by any other event entirely outside the control of either the Procuring Entity or the Contractor, the Project Manager shall certify that the Contract has been frustrated. The Contractor shall make the Site safe and stop work as quickly as possible after receiving this certificate and shall be paid for all work carried out before receiving it and for any work carried out afterwards to which a commitment was made.

SECTION IX - SPECIAL CONDITIONS OF CONTRACT

Number of GC Clause	Amendments of, and Supplements to, Clauses in the General Conditions of Contract
A. General	
GCC 1.1 (q)	The Procuring Entity is CENTRAL RIFT VALLEY WATER WORKS DEVELOPMENT AGENCY
GCC 1.1 (u)	The Intended Completion Date for the whole of the Works shall be 180 days from the date of order to commence works by the Project Manager.
GCC 1.1 (x)	<p>The Project Manager General Manager-Infrastructure Development Manager (GM-IDM) Central Rift Valley Water Works Development Agency Maji Plaza, Prisons Road P.O. Box 2451-20100 Nakuru, Kenya Mobile No. 0725999000 E-mail: info@crvwda.go.ke</p>
GCC 1.1 (z)	<i>The Site is located 44km from Marigat Town, Baringo South Constituency in Baringo County</i>
GCC 1.1 (cc)	The Start Date shall be the date the project Manager orders to commence works/or possession of site.
GCC 1.1 (gg)	<p>The Works consist of;</p> <ol style="list-style-type: none"> 1. Construction of intake 2. Gravity and rising mains 3. Pumping system 4. Masonry storage tanks 5. auxiliary Works
Number of GC Clause	Amendments of, and Supplements to, Clauses in the General Conditions of Contract
GCC 2.2	Sectional Completions are: <i>N/A</i>
GCC 5.1	The Project manager <i>may</i> delegate any of his duties and responsibilities.
GCC 8.1	Schedule of other contractors: <i>N/A</i>

Number of GC Clause	Amendments of, and Supplements to, Clauses in the General Conditions of Contract
GCC 13.1	<p>The minimum insurance amounts and deductibles shall be:</p> <p>(a) loss of or damage to the Works, Plant, and Materials Kshs 100,000,</p> <p>(b) loss of or damage to Equipment Kshs 100,000</p> <p>(c) loss of or damage to property (except the Works, Plant, Materials, and Equipment) in connection with the Contract Kshs500,000</p> <p>(d) personal injury or death:</p> <p>(i) Of contractor's Employees: Kshs 200,000 for one incidence, number of incidences unlimited.</p> <p>(i) Of other people: Kshs200,000 for one incidence, number of incidences unlimited.</p>
GCC 14.1	Site Data are: The Bidder shall conduct own site inspections and investigations
GCC 20.1	The Site Possession Date(s) shall be seven days after the date of order to commence
GCC 9.1	<p>Key Personnel GCC 9.1 is replaced with the following:</p> <p>Key Personnel are the Contractor's personnel named in this GCC 9.1 of the Special Conditions of Contract. The Contractor shall employ the Key Personnel and use the equipment identified in its Bid, to carry out the Works or other personnel and equipment approved by the Project Manager. The Project Manager shall approve any proposed replacement of Key Personnel and equipment only if their relevant qualifications or characteristics are substantially equal to or better than those proposed in the Bid.</p> <p>Key Personnel.</p> <ul style="list-style-type: none"> • Site Agent • Foreman
Number of GC Clause	Amendments of, and Supplements to, Clauses in the General Conditions of Contract
	works.
GCC 23.1 & GCC 23.2	Appointing Authority for the Adjudicator: Chartered Institute of Arbitrators (Kenya Chapter)

	<p>Hourly rate and types of reimbursable expenses to be paid to the Adjudicator: Kshs 20,000</p> <p>Types of reimbursable expenses to be paid to the Adjudicator include: the reimbursable expenses shall include: travelling, accommodation, report writing and communication expenses.</p> <p>(a) Travelling expenses (b) accommodation expenses (c) report production and mailing expenses communication expenses</p> <p>Arbitration will take place at Nairobi in accordance with the current rules and regulations published of the Chartered Institute of Arbitrators (Kenya Chapter)</p>
B. Time Control	
GCC 26.1	The Contractor shall submit for approval a Program for the Works within 7 days from the date of the Letter of Acceptance.
GCC 26.3	<p>The period between Program updates is 30 days.</p> <p>The amount to be withheld for late submission of an updated Program is Ksh One Hundred Thousand (100,000).</p>
C. Quality Control	
GCC 34.1	The Defects Liability Period is (180 days) . From date of issuance of substantial completion certificate.
D. Cost Control	
GCC 44.1	The currency of the Procuring Entity's Country is: <i>Kenya Shillings</i>
GCC 45.1	<p>The Contract IS NOT subject to price adjustment in accordance with GCC Clause 45, and the following information regarding coefficients DOES NOT apply.</p> <p><i>[Price adjustment is mandatory for contracts which provide for time of completion exceeding 18 months]</i></p>
Number of GC Clause	Amendments of, and Supplements to, Clauses in the General Conditions of Contract
	<p>The coefficients for adjustment of prices are:</p> <p>(a) <i>[insert percentage]</i> percent nonadjustable element (coefficient A). (ib) <i>[insert percentage]</i> percent adjustable element (coefficient B).</p> <p>(c) The Index I for shall be <i>[insert index]</i>.</p>
GCC 46.1	The proportion of payments retained is: <i>10%</i> of value of works of Interim Payment Certificate'.

GCC 47.1	The liquidated damages for the whole of the Works are <i>0.1% of final Contract Price</i> per day. The maximum amount of liquidated damages for the whole of the Works is <i>10%</i> of the final Contract Price.
GCC 48.1	The Bonus for the whole of the Works is <i>[insert percentage of final Contract Price]</i> per day. The maximum amount of Bonus for the whole of the Works is <i>[insert percentage]</i> of the final Contract Price. NOT APPLICABLE
GCC 49.1	The amount of advance payment shall be NOT APPLICABLE
GCC 50.1	The Performance Security - 1% of the contract sum in the form of unconditional Bank Guarantee (b) Performance Security –in the amount(s) of one percent of the Accepted Contract Amount and in the same currency (ies) of the Accepted Contract Amount.
E. Finishing the Contract	
GCC 56.1	The date by which operating and maintenance manuals are required is least 10 days to prior taking over of completed project The date by which “as built” drawings are required is 30 days after taking over of completed project.
GCC 56.2	The amount to be withheld for failing to produce “as built” drawings and/or operating and maintenance manuals by the date required in GCC 58.1 is Kshs. Two hundred and fifty thousand Only (250,000).
GCC 57.2 (g)	The maximum number of days is: 30 days
Number of GC Clause	Amendments of, and Supplements to, Clauses in the General Conditions of Contract
GCC 58.1	The percentage to apply to the value of the work not completed, representing the Procuring Entity’s additional cost for completing the Works, is 30% of the value of work not completed.

FORM No 1: NOTIFICATION OF INTENTION TO AWARD

This Notification of Intention to Award shall be sent to each Tenderer that submitted a Tender. Send this Notification to the Tenderer's Authorized Representative named in the Tender Information Form on the format below.

FORMAT

1. For the attention of Tenderer's Authorized Representative

- i) Name:..... [insert Authorized Representative's name]
- ii) Address:..... [insert Authorized Representative's Address]
- iii) Telephone:[insert Authorized Representative's telephone/fax numbers]
- iv) Email Address: [insert Authorized Representative's email address]

[IMPORTANT: insert the date that this Notification is transmitted to Tenderers. The Notification must be sent to all Tenderers simultaneously. This means on the same date and as close to the same time as possible.]

2. Date of transmission: [email]..... on [date]... (local time).....

This Notification is sent by (Name and designation) _____

3. Notification of Intention to Award

- i) Procuring Entity:..... [insert the name of the Procuring Entity]
- ii) Project:[insert name of project]
- iii) Contract title:.....[insert the name of the contract]
- iv) Country: [insert country where ITT is issued]
- v) ITT No:[insert ITT reference number from Procurement Plan]

This Notification of Intention to Award (Notification) notifies you of our decision to award the above contract. The transmission of this Notification begins the Standstill Period. During the Standstill Period, you may:

4. Request a debriefing in relation to the evaluation of your tender

Submit a Procurement-related Complaint in relation to the decision to award the contract.

- a) The successful tenderer
 - i) Name of successful Tender _____
 - ii) Address of the successful Tender _____

iii) Contract price of the successful Tender Kenya Shillings _____ (in
wo

b) Other Tenderers

Names of all Tenderers that submitted a Tender. If the Tender's price was evaluated include the evaluated price as well as the Tender price as read out. For Tenders not evaluated, give one main reason the Tender was unsuccessful.

SNo	Name of Tender	Tender Price as read out	Tender's evaluated price (Note a)	One Reason Why not Evaluated
1				
2				
3				
4				
5				
6				

(Note a) State NE if not evaluated

5. How to request a debriefing

- a) DEADLINE: The deadline to request a debriefing expires at midnight on [insert date] (local time).
- b) You may request a debriefing in relation to the results of the evaluation of your Tender. If you decide to request a debriefing your written request must be made within three (5) Business Days of receipt of this Notification of Intention to Award.
- c) Provide the contract name, reference number, name of the Tenderer, contact details; and address the request for debriefing as follows:
 - i) Attention: [insert full name of person, if applicable]
 - ii) Title/position: [insert title/position]
 - ii) Agency: [insert name of Procuring Entity]
 - iii) Email address: [insert email address]
- d) If your request for a debriefing is received within the 3 Days deadline, we will provide the debriefing within five (3) Business Days of receipt of your request. If we are unable to provide the debriefing within this period, the Standstill Period shall be extended by five (3) Days after the date that the debriefing is provided. If this happens, we will notify you and confirm the date that the extended Standstill Period will end.
- e) The debriefing may be in writing, by phone, video conference call or in person. We shall promptly advise you in writing how the debriefing will take place and confirm the date and time.
- f) If the deadline to request a debriefing has expired, you may still request a debriefing. In this case, we will provide the debriefing as soon as practicable, and normally no later than fifteen (15) Days from the date of publication of the Contract Award Notice.

6. How to make a complaint

a) Period: Procurement-related Complaint challenging the decision to award shall be

Fairness, Transparency & Accountability

submitted by midnight, [insert date] (local time).

- b) Provide the contract name, reference number, name of the Tenderer, contact details; and address the Procurement-related Complaint as follows:
 - i) Attention: [insert full name of person, if applicable]
 - ii) Title/position: [insert title/position]
 - iii) Agency: [insert name of Procuring Entity]
 - iv) Email address: [insert email address]
- c) At this point in the procurement process, you may submit a Procurement-related Complaint challenging the decision to award the contract. You do not need to have requested, or received, a debriefing before making this complaint. Your complaint must be submitted within the Standstill Period and received by us before the Standstill Period ends.
- d) Further information: For more information refer to the Public Procurement and Disposals Act 2015 and its Regulations available from the Website info@ppra.go.ke or complaints@ppra.go.ke. You should read these documents before preparing and submitting your complaint.
- e) There are four essential requirements:
 - i) You must be an 'interested party'. In this case, that means a Tenderer who submitted a Tender in this tendering process, and is the recipient of a Notification of Intention to Award.
 - ii) The complaint can only challenge the decision to award the contract.
 - iii) You must submit the complaint within the period stated above.
 - iv) You must include, in your complaint, all of the information required to support your complaint.

7. Standstill Period

- i) DEADLINE: The Standstill Period is due to end at midnight on [insert date] (local time).
- ii) The Standstill Period lasts ten (14) Days after the date of transmission of this Notification of Intention to Award.
- iii) The Standstill Period may be extended as stated in paragraph Section 5 (d) above.

If you have any questions regarding this Notification please do not hesitate to contact us. On behalf of the Procuring Entity:

Signature: _____ **Name:** _____

Title/position: _____ **Telephone:** __ **Email:** _____

FORM NO. 2 - REQUEST FOR REVIEW

FORM FOR REVIEW (r.203(1))

PUBLIC PROCUREMENT ADMINISTRATIVE REVIEW BOARD

APPLICATION NO.....OF.....20.....

BETWEEN

.....**APPLICANT**

AND

.....**RESPONDENT (Procuring Entity)**

Request for review of the decision of the..... (Name of the Procuring Entity ofdated the...day of20.....in the matter of Tender No.....of20..... for..... (Tender description).

REQUEST FOR REVIEW

I/We.....,the above named Applicant(s), of address: Physical address.....P. O. Box No..... Tel. No.....Email....., hereby request the Public Procurement Administrative Review Board to review the whole/part of the above mentioned decision on the following grounds , namely:

- 1.
- 2.

By this memorandum, the Applicant requests the Board for an order/orders that: 1.

- 2.

SIGNED(Applicant) Dated on.....day of/...20.....

FOR OFFICIAL USE ONLY Lodged with the Secretary Public Procurement Administrative Review Board on.....day of20.....

SIGNED

Board Secretary

FORM NO 3: LETTER OF AWARD

[letterhead paper of the Procuring Entity] [date]

To: *[name and address of the Contractor]*

This is to notify you that your Tender dated *[date]* for execution of the *[name of the Contract and identification number, as given in the Contract Data]* for the Accepted Contract Amount *[amount in numbers and words] [name of currency]*, as corrected and modified in accordance with the Instructions to Tenderers, is hereby accepted by *(name of Procuring Entity)*.

You are requested to furnish the Performance Security within 30 days in accordance with the Conditions of Contract, using, for that purpose, one of the Performance Security Forms included in Section VIII, Contract Forms, of the Tender Document.

Authorized Signature:.....

Name and Title of Signatory:.....

Name of Procuring Entity.....

Attachment: *Contract Agreement*.....

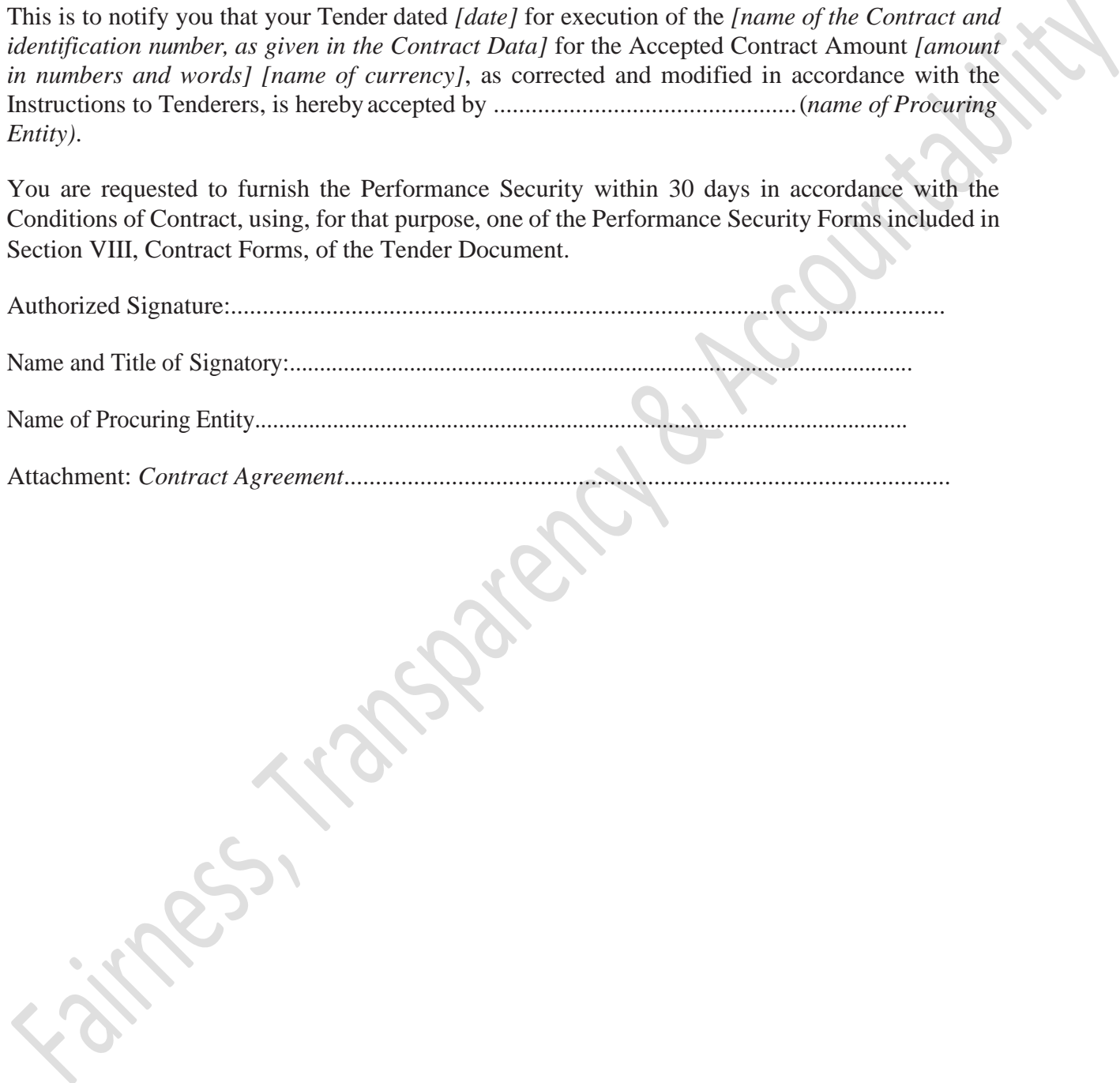

FORM NO 4: CONTRACT AGREEMENT

THIS AGREEMENT made the _____ day of _____, 20____,
between _____ of _____ (hereinafter “the
Procuring Entity”), of the one part, and _____ of _____
_____ (hereinafter “the Contractor”), of the
otherpart:

WHEREAS the Procuring Entity desires that the Works known as _____ should be
executed by the Contractor, and has accepted a Tender by the Contractor for the execution and completion
of these Works and the remedying of any defects therein,

The Procuring Entity and the Contractor agree as follows:

1. In this Agreement words and expressions shall have the same meanings as are respectively assigned to them in the Contract documents referred to.
2. The following documents shall be deemed to form and be read and construed as part of this Agreement. This Agreement shall prevail over all other Contract documents.
 - a) the Letter of Acceptance
 - b) the Letter of Tender
 - c) the addenda Nos _____ (if any)
 - d) the Special Conditions of Contract
 - e) the General Conditions of Contract;
 - f) the Specifications
 - g) the Drawings; and
 - h) the completed Schedules and any other documents forming part of the contract.
3. In consideration of the payments to be made by the Procuring Entity to the Contractor as specified in this Agreement, the Contractor hereby covenants with the Procuring Entity to execute the Works and to remedy defects therein in conformity in all respects with the provisions of the Contract.
4. The Procuring Entity hereby covenants to pay the Contractor in consideration of the execution and completion of the Works and the remedying of defects therein, the Contract Price or such other sum as may become payable under the provisions of the Contract at the times and in the manner prescribed by the Contract.

IN WITNESS whereof the parties hereto have caused this Agreement to be executed in accordance with the Laws of Kenya on the day, month and year specified above.

Signed and sealed by _____ (for the Procuring Entity)

Signed and sealed by _____ (for the Contractor).

FORM NO. 5 - PERFORMANCE SECURITY

[Option 1 - Unconditional Demand Bank Guarantee]

[Guarantor letterhead]

Beneficiary: _____ *[insert name and Address of Procuring Entity]* **Date:**

_____ *[Insert date of issue]*

Guarantor: *[Insert name and address of place of issue, unless indicated in the letterhead]*

1. We have been informed that _____ (hereinafter called "the Contractor") has entered into Contract No. _____ dated _____ with (name of Procuring Entity) _____ (the Procuring Entity as the Beneficiary), for the execution of _____ (hereinafter called "the Contract").
2. Furthermore, we understand that, according to the conditions of the Contract, a performance guarantee is required.
3. At the request of the Contractor, we as Guarantor, hereby irrevocably undertake to pay the Beneficiary any sum or sums not exceeding in total an amount of _____ (in words),¹ such sum being payable in the types and proportions of currencies in which the Contract Price is payable, upon receipt by us of the Beneficiary's complying demand supported by the Beneficiary's statement, whether in the demand itself or in a separate signed document accompanying or identifying the demand, stating that the Applicant is in breach of its obligation(s) under the Contract, without the Beneficiary needing to prove or to show grounds for your demand or the sum specified therein.
4. This guarantee shall expire, no later than the Day of, 2.....², and any demand for payment under it must be received by us at the office indicated above on or before that date.
5. The Guarantor agrees to a one-time extension of this guarantee for a period not to exceed *[six months]* *[one year]*, in response to the Beneficiary's written request for such extension, such request to be presented to the Guarantor before the expiry of the guarantee."

[Name of Authorized Official, signature(s) and seals/stamps].

Note: *All italicized text (including footnotes) is for use in preparing this form and shall be deleted from the final product.*

FORM No. 6 - PERFORMANCE SECURITY

[Option 2– Performance Bond]

[Note: Procuring Entities are advised to use Performance Security – Unconditional Demand Bank Guarantee instead of Performance Bond due to difficulties involved in calling Bond holder to action]

[Guarantor letterhead or SWIFT identifier code]

Beneficiary: _____ *[insert name and Address of Procuring Entity]*

Date: _____ *[Insert date of issue].*

PERFORMANCE BOND No.: _____

Guarantor: *[Insert name and address of place of issue, unless indicated in the letterhead]*

1. By this Bond _____ as Principal (hereinafter called “the Contractor”) and _____] as Surety (hereinafter called “the Surety”), are held and firmly bound unto _____] as Obligee (hereinafter called “the Procuring Entity”) in the amount of _____ for the payment of which sum well and truly to be made in the types and proportions of currencies in which the Contract Price is payable, the Contractor and the Surety bind themselves, their heirs, executors, administrators, successors and assigns, jointly and severally, firmly by these presents.
2. WHEREAS the Contractor has entered into a written Agreement with the Procuring Entity dated the _____ day of _____, 20, for _____ in accordance with the documents, plans, specifications, and amendments thereto, which to the extent herein provided for, are by reference made part hereof and are hereinafter referred to as the Contract.
3. NOW, THEREFORE, the Condition of this Obligation is such that, if the Contractor shall promptly and faithfully perform the said Contract (including any amendments thereto), then this obligation shall be null and void; otherwise, it shall remain in full force and effect. Whenever the Contractor shall be, and declared by the Procuring Entity to be, in default under the Contract, the Procuring Entity having performed the Procuring Entity's obligations thereunder, the Surety may promptly remedy the default, or shall promptly:
 - 1) complete the Contract in accordance with its terms and conditions; or
 - 2) obtain a tender or tenders from qualified tenderers for submission to the Procuring Entity for completing the Contract in accordance with its terms and conditions, and upon determination by the Procuring Entity and the Surety of the lowest responsive Tenderers, arrange for a Contract between such Tenderer, and Procuring Entity and make available as work progresses (even though there should be a default or a succession of defaults under the Contract or Contracts of completion arranged under this paragraph) sufficient funds to pay the cost of completion less the Balance of the Contract Price; but not exceeding, including other costs and damages for which the Surety may be liable hereunder, the amount set forth in the first paragraph hereof. The term “Balance of the Contract Price,” as used in this paragraph, shall mean the total amount payable by Procuring Entity to Contractor under the Contract, less the amount properly paid by Procuring Entity to Contractor; or
 - 3) pay the Procuring Entity the amount required by Procuring Entity to complete the Contract in accordance with its terms and conditions up to a total not exceeding the amount of this Bond.

4. The Surety shall not be liable for a greater sum than the specified penalty of this Bond.
5. Any suit under this Bond must be instituted before the expiration of one year from the date of the issuing of the Taking-Over Certificate. No right of action shall accrue on this Bond to or for the use of any person or corporation other than the Procuring Entity named herein or the heirs, executors, administrators, successors, and assigns of the Procuring Entity.
6. In testimony whereof, the Contractor has hereunto set his hand and affixed his seal, and the Surety has caused these presents to be sealed with his corporate seal duly attested by the signature of his legal representative, this day _____ of _____ 20 .

SIGNED ON _____ on behalf of By _____ in the capacity of _____ In the presence of _____

SIGNED ON _____ on behalf of By _____ in the capacity of _____ In the presence of _____

FORM NO. 7 - ADVANCE PAYMENT SECURITY

[Demand Bank Guarantee]

[Guarantor letterhead]

Beneficiary: _____ [Insert name and Address of Procuring Entity]

Date: _____ [Insert date of issue]

ADVANCE PAYMENT GUARANTEE No.: _____ [Insert guarantee reference number]

Guarantor: _____ [Insert name and address of place of issue, unless indicated in the letterhead]

1. We have been informed that _____ (hereinafter called "the Contractor") has entered into Contract No. _____ dated _____ with the Beneficiary, for the execution of _____ (hereinafter called "the Contract").
2. Furthermore, we understand that, according to the conditions of the Contract, an advance payment in the sum _____ (in words) is to be made against an advance payment guarantee.
3. At the request of the Contractor, we as Guarantor, hereby irrevocably undertake to pay the Beneficiary any sum or sums not exceeding in total an amount of _____ (in words _____) ¹ upon receipt by us of the Beneficiary's complying demand supported by the Beneficiary's statement, whether in the demand itself or in a separate signed document accompanying or identifying the demand, stating either that the Applicant:
 - a) has used the advance payment for purposes other than the costs of mobilization in respect of the Works; or
 - b) has failed to repay the advance payment in accordance with the Contract conditions, specifying the amount which the Applicant has failed to repay.
4. A demand under this guarantee may be presented as from the presentation to the Guarantor of a certificate from the Beneficiary's bank stating that the advance payment referred to above has been credited to the Contractor on its account number at .
5. The maximum amount of this guarantee shall be progressively reduced by the amount of the advance payment repaid by the Contractor as specified in copies of interim statements or payment certificates which shall be presented to us. This guarantee shall expire, at the latest, upon our receipt of a copy of the interim payment certificate indicating that ninety (90) percent of the Accepted Contract Amount, less provisional sums, has been certified for payment, or on the _____ day of _____, 20², ² whichever is earlier. Consequently, ~~any~~ demand for payment under this guarantee must be received by us at this office on or before that date.
6. The Guarantor agrees to a one-time extension of this guarantee for a period not to exceed [six months][one year], in response to the Beneficiary's written request for such extension, such request to be presented to the Guarantor before the expiry of the guarantee.

Name of Authorized Official, signature(s) and seals/stamps]

FORM NO. 8 - RETENTION MONEY SECURITY

[Demand Bank Guarantee]

[Guarantor letterhead]

Beneficiary: _____ *[Insert name and Address of Procuring Entity]*

Date: _____ *[Insert date of issue]*

Advance payment guarantee no. *[Insert guarantee reference number]*

Guarantor: *[Insert name and address of place of issue, unless indicated in the letterhead]*

1. We have been informed that _____ *[insert name of Contractor, which in the case of a joint venture shall be the name of the joint venture]* (hereinafter called "the Contractor") has entered into Contract No. _____ *[insert reference number of the contract]* dated _____ with _____ the Beneficiary, for the execution of _____ *[insert name of contract and brief description of Works]* (hereinafter called "the Contract").
2. Furthermore, we understand that, according to the conditions of the Contract, the Beneficiary retains moneys up to the limit set forth in the Contract ("the Retention Money"), and that when the Taking-Over Certificate has been issued under the Contract and the first half of the Retention Money has been certified for payment, and payment of *[insert the second half of the Retention Money]* is to be made against a Retention Money guarantee.
3. At the request of the Contractor, we, as Guarantor, hereby irrevocably undertake to pay the Beneficiary any sum or sums not exceeding in total an amount of *[insert amount in figures]* (*[insert amount in words* _____ *]*)¹ upon receipt by us of the Beneficiary's complying demand supported by the Beneficiary's statement, whether in the demand itself or in a separate signed document accompanying or identifying the demand, stating that the Contractor is in breach of its obligation(s) under the Contract, without your needing to prove or show grounds for your demand or the sum specified therein.
4. A demand under this guarantee may be presented as from the presentation to the Guarantor of a certificate from the Beneficiary's bank stating that the second half of the Retention Money as referred to above has been credited to the Contractor on its account number ___ at ___ *[insert name and address of Applicant's bank]*.
5. This guarantee shall expire no later than the Day of, 2.....², and any demand for payment under it must be received by us at the office indicated above on or before that date.
6. The Guarantor agrees to a one-time extension of this guarantee for a period not to exceed *[six months]* *[one year]*, in response to the Beneficiary's written request for such extension, such request to be presented to the Guarantor before the expiry of the guarantee.

[Name of Authorized Official, signature(s) and seals/stamps]

FORM NO. 9 BENEFICIAL OWNERSHIP DISCLOSURE FORM

Tender Reference No.: _____ [insert identification no] Name of the Assignment: _____ [insert name of the assignment] to: _____ [insert complete name of Procuring Entity]

In response to your notification of award dated _____ [insert date of notification of award] to furnish additional information on beneficial ownership: [select one option as applicable and delete the options that are not applicable]

I) We here by provide the following beneficial ownership information.

Details of beneficial ownership

Identity of Beneficial Owner	Directly or indirectly holding 25% or more of the shares (Yes / No)	Directly or indirectly holding 25 % or more of the Voting Rights (Yes / No)	Directly or indirectly having the right to appoint a majority of the board of the directors or an equivalent governing body of the Tenderer (Yes / No)
[include full name (last, middle, first), nationality, country of residence]			

OR

ii) We declare that there is no Beneficial Owner meeting one or more of the following conditions: directly or indirectly holding 25% or more of the shares. Directly or indirectly holding 25% or more of the voting rights. Directly or indirectly having the right to appoint a majority of the board of directors or equivalent governing body of the Tenderer.

OR

We declare that we are unable to identify any Beneficial Owner meeting one or more of the following conditions. [If this option is selected, the Tenderer shall provide explanation on why it is unable to identify any Beneficial Owner]

Directly or indirectly holding 25% or more of the shares. Directly or indirectly holding 25% or more of the voting rights.

Directly or indirectly having the right to appoint a majority of the board of directors or equivalent governing body of the Tenderer]”

Name of the Tenderer:*[insert complete name of the Tenderer]

Name of the person duly authorized to sign the Tender on behalf of the Tenderer: ** [insert complete name of person duly authorized to sign the Tender]

Title of the person signing the Tender: [insert complete title of the person signing the Tender]

Signature of the person named above: [insert signature of person whose name and capacity are shown above]

Date signed [insert date of signing] day of..... [Insert month], [insert year]

Fairness, Transparency & Accountability

ANNEX I: DRAWINGS

- i. Gravity Mains and Rising Main
- ii. Solar Structure
- iii. Cattle Trough

Fairness, Transparency & Accountability

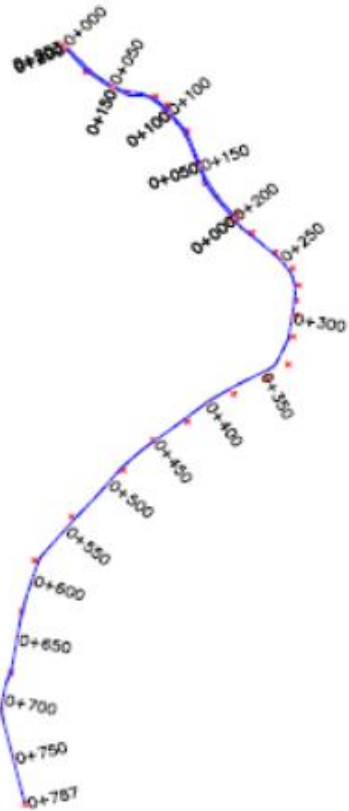

Gravity Mains PROFILE

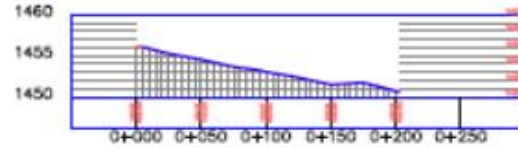

Rising Main PROFILE

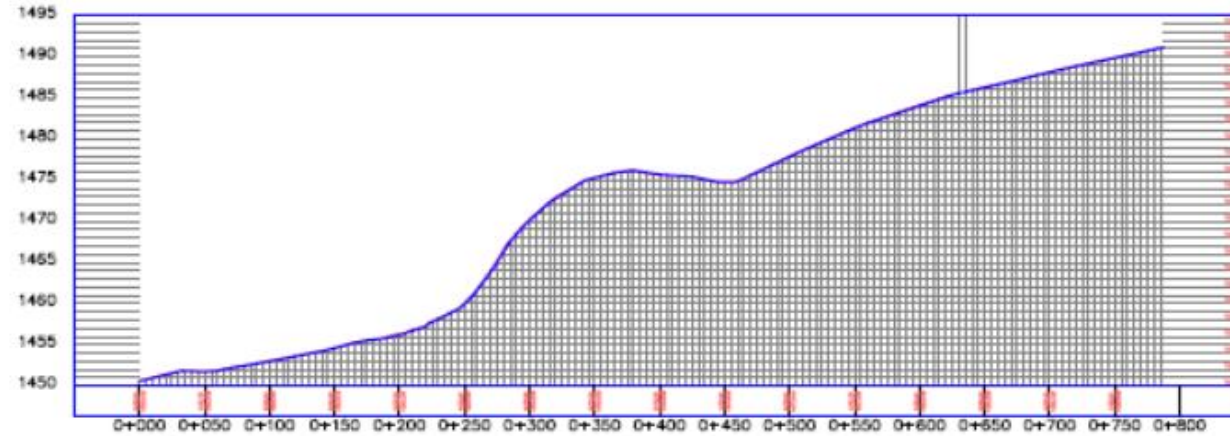

	<p style="text-align: center;">CLIENT</p> <p>CENTRAL RIFT VALLEY WATER WORKS DEVELOPMENT AGENCY</p> <p>P.O BOX 2451-20100 NAKURU</p>	<p>PROJECT: BEKIBON WATER SUPPLY PROJECT</p> <p>COUNTY: BARINGO COUNTY, BARINGO SOUTH SUB-COUNTY</p>	<p>DRAWN BY: K.K</p> <p>DESIGNED BY: K.K</p> <p>CHECKED BY: L.MBURU</p> <p>APPROVED BY: J.SALEE</p>
---	--	--	---

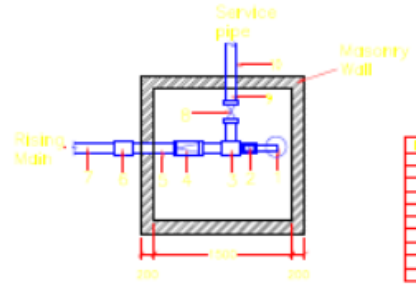
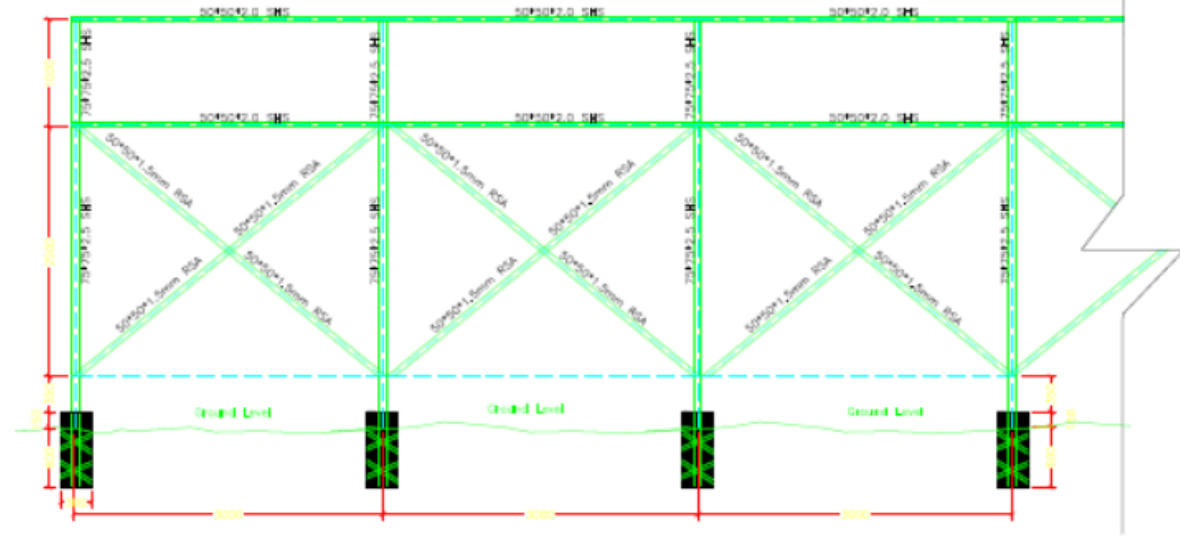
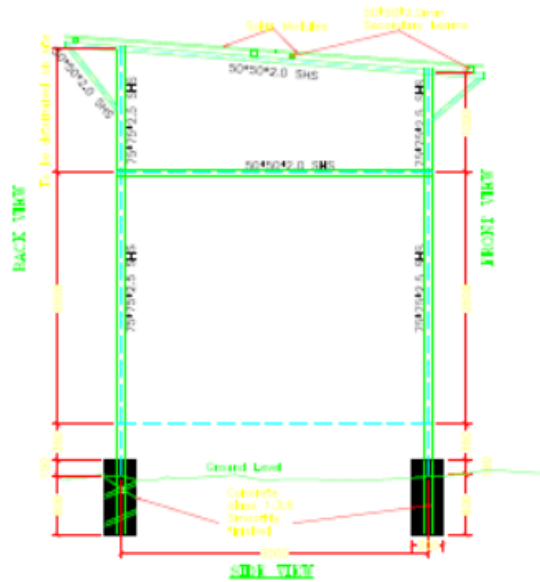

ITEM	DESCRIPTION
1	PIPE
2	PIPE
3	PIPE
4	PIPE
5	PIPE
6	PIPE
7	PIPE
8	PIPE
9	PIPE
10	PIPE
11	PIPE
12	PIPE
13	PIPE
14	PIPE
15	PIPE
16	PIPE
17	PIPE
18	PIPE
19	PIPE
20	PIPE

BORRHOLE CHAMBER PLAN

SCHEDULE OF PIPES AND FITTINGS

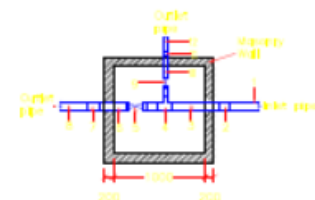

ITEM	DESCRIPTION
1	PIPE
2	PIPE
3	PIPE
4	PIPE
5	PIPE
6	PIPE
7	PIPE
8	PIPE
9	PIPE
10	PIPE
11	PIPE
12	PIPE
13	PIPE
14	PIPE
15	PIPE
16	PIPE
17	PIPE
18	PIPE
19	PIPE
20	PIPE

MASONRY CHAMBER PLAN

SCHEDULE OF PIPES AND FITTINGS

NOTES

1. All dimensions are in millimeters unless otherwise stated.
2. Only figured dimensions to be taken from the drawing.
3. All metal works to be painted with two coats of Aluminium paint.
3. Joints to be fully welded with 8mm thickness.

DESIGN BY: KURGAI
DRAWN BY: KURGAI
CHECKED BY: C. MURAGE
APPROVED BY: ENG. S.K. OUMA

CLIENT CENTRAL RIFT VALLEY WATER WORKS DEVELOPMENT AGENCY P.O. BOX 2491-20100 KAKURU
DRAWING TITLE PROPOSED GROUND MOUNTED SOLAR STRUCTURE



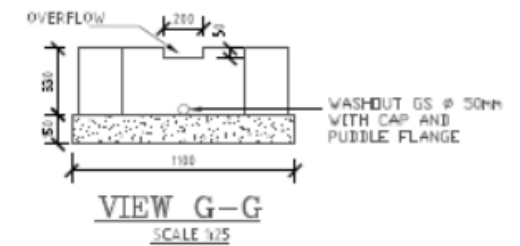
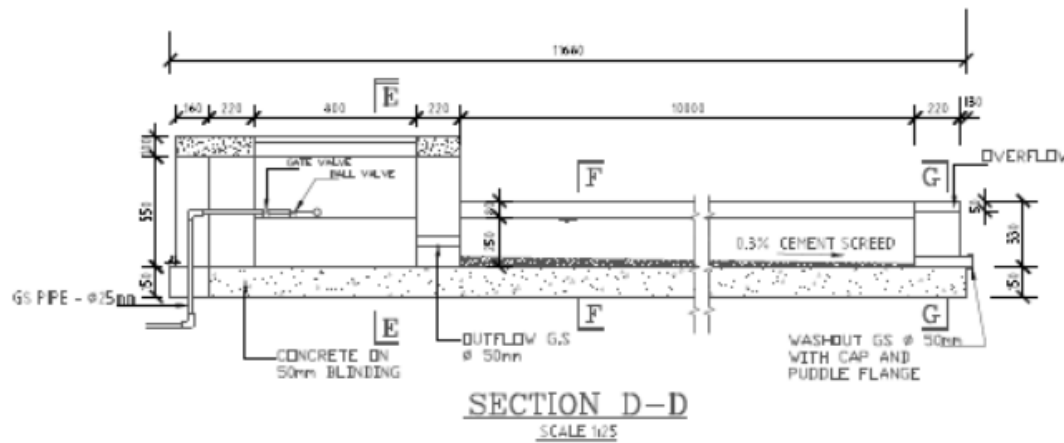
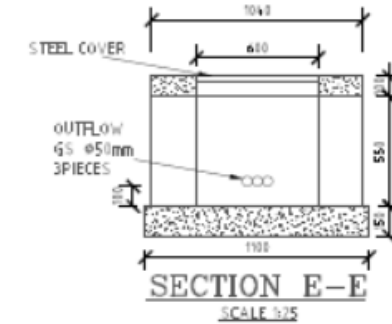
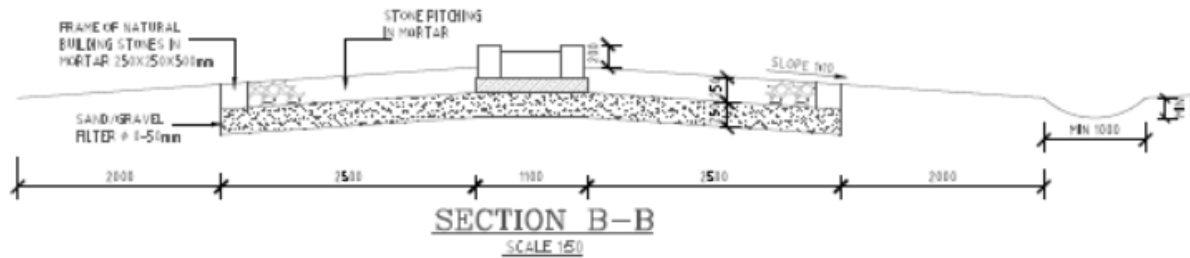
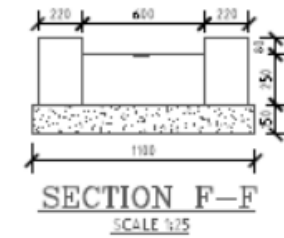
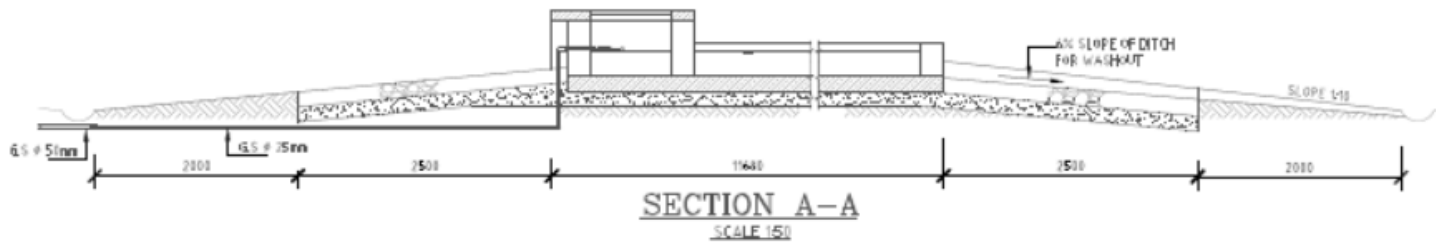

CENTRAL RIFT VALLEY WATER WORKS DEVELOPMENT AGENCY			
CATTLE TROUGH			
DESIGNED	K.K & D.N	2023	SHEET 1 OF 1
DRAWN	K.K & D.N	2023	SCALE: AS SHOWN
DIGITIZED	K.K & D.N	2023	DRG. NO.
CHECKED	L.M	2023	CRVWDA
APPROVED	J.M.S	2023	018-TYPE-026A